

| PART CHARACTERISTICS | | CKT. NO. | DIM. 'A' | DIM. 'B' |
|----------------------|----------------------|----------|---------------|---------------|
| NUMBER OF POSITION | ASSEMBLY ITEM NUMBER | | | |
| | | 2 | .152/(3.86) | N/A |
| 02 | 43025-0208 | 4 | .270/(6.85) | .118/(3.00) |
| 04 | 43025-0408 | 6 | .388/(9.85) | .236/(6.00) |
| 06 | 43025-0608 | 8 | .506/(12.85) | .354/(9.00) |
| 08 | 43025-0808 | 10 | .624/(15.85) | .472/(12.00) |
| 10 | 43025-1008 | 12 | .742/(18.85) | .591/(15.00) |
| 12 | 43025-1208 | 14 | .860/(21.85) | .709/(18.00) |
| 14 | 43025-1408 | 16 | .978/(24.85) | .827/(21.00) |
| 16 | 43025-1608 | 18 | 1.096/(27.85) | .945/(24.00) |
| 18 | 43025-1808 | 20 | 1.215/(30.85) | 1.063/(27.00) |
| 20 | 43025-2008 | 22 | 1.333/(33.85) | 1.181/(30.00) |
| 22 | 43025-2208 | 24 | 1.451/(36.85) | 1.299/(33.00) |
| 24 | 43025-2408 | | | |

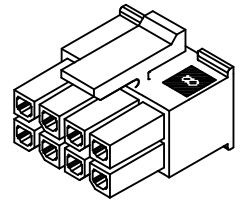
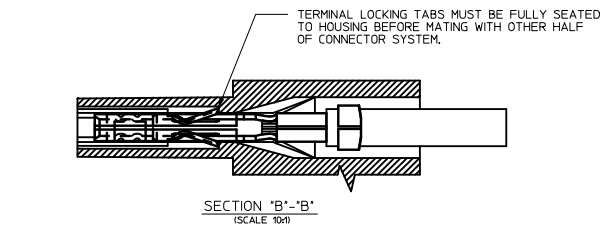
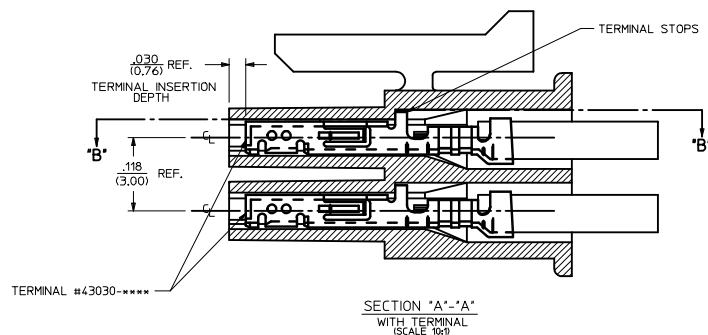
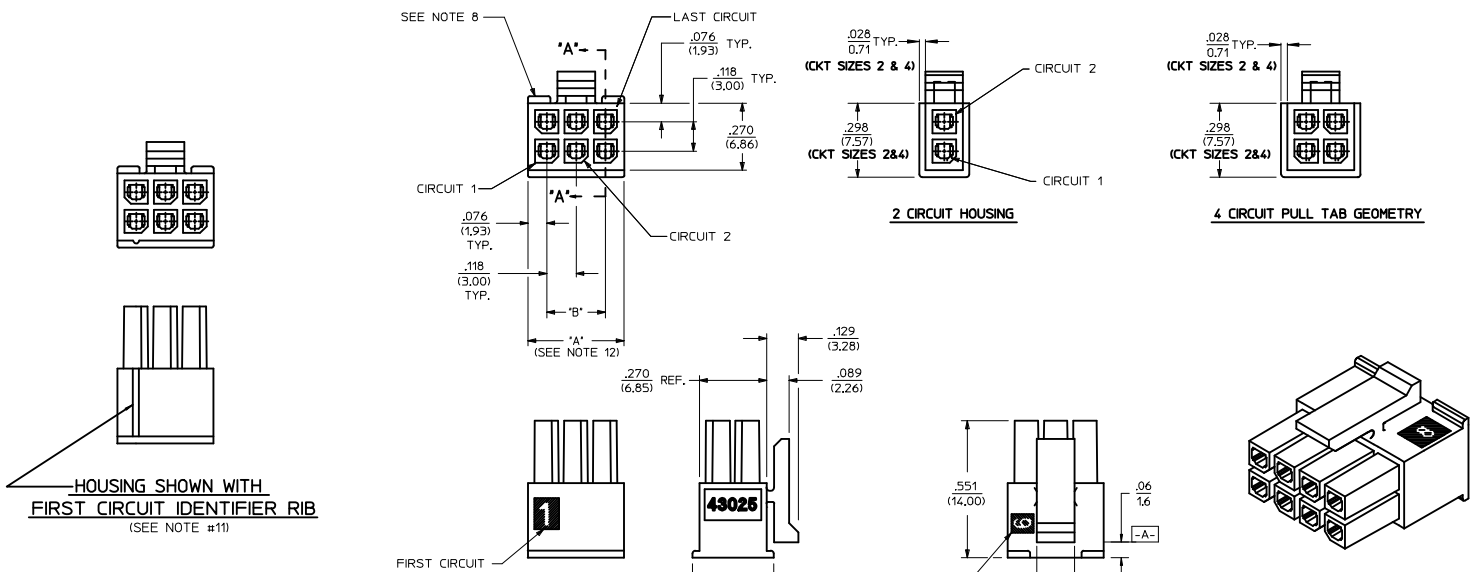

- NOTES:**
- HOUSING MATERIAL: UNFILLED NYLON, RATED UL 94V-0, IEC 60335-1, 4TH EDITION GLOW WIRE CAPABLE. COLOR IS BLACK.
 - FINISH: N/A
 - PRODUCT SPECIFICATION: PS-43045
 - PACKAGING SPECIFICATION: PK-43025-001
 - THIS RECEPTACLE MATES WITH 43020, 43045.
 - THIS RECEPTACLE TO BE USED WITH MOLEX FEMALE TERMINAL SERIES 43030 OR 46235. SEE SECTION 'A'-'A' FOR TERMINAL ORIENTATION IN HOUSING.
 - FOR OVERMOLDING PARAMETERS SEE ENGINEERING SPECIFICATION #SDES-43025-1000.
 - TOP PULL TABS ARE NOT AVAILABLE ON 2 AND 4 CIRCUIT PARTS.
 - MOLEX RECOMMENDS THE USE OF MICRO-FIT TEST PLUG, SERIES NO. 44242-**** WHENEVER TESTING IS PERFORMED. TEST PLUGS MUST NOT BE USED FOR MAKE OR BREAK UNDER LOAD. MOLEX DOES NOT RECOMMEND USING STANDARD MATING COMPONENTS FOR HARNESS TESTING PURPOSES.
 - SOME HOUSINGS MAY HAVE A SMALL GATE BLEMISH NEAR THE GATE THAT DOES NOT AFFECT FUNCTIONALITY.
 - HOUSINGS HAVE EITHER AN IDENTIFIER RIB OR ENGRAVED '*' SYMBOL TO INDICATE CIRCUIT #1. IDENTIFIER TYPE IS TOOL DEPENDENT AND NOT SELECTABLE.
 - DIMENSION 'A' MEASURED AT DATUM [A].
 - THIS PART CONFORMS TO CLASS 'B' REQUIREMENTS OF COSMETIC SPECIFICATION PS-45499-002.

| | | | | | | | | | |
|---|--------------------------------------|---------------------------------------|--|---|--|--|--------------|------------------------|--|
| ADD NOTE 12 IEC NO: UCP2013-4/30 DFWANUNGVEN 2012/10/10 CHIKOSUSEK 2012/10/10 APPRESMITH 2012/10/12 A6 | QUALITY SYMBOLS ▽=0 ▽=0 ▽=0 | GENERAL TOLERANCES (UNLESS SPECIFIED) | | DIMENSION STYLE | | SCALE | DESIGN UNITS | THIRD ANGLE PROJECTION | |
| | | | | IN/MM | | --- | METRIC | | |
| | | 4 PLACES ± --- ± --- | | DRAWN BY DATE | | TITLE | | | |
| | | 3 PLACES ± --- ± --- | | MKIPPER 2008/01/22 | | MICRO-FIT (3.0) 2 THRU 24 CIRCUIT RECEPTACLE, HALOGEN-FREE | | | |
| 2 PLACES ± 0.25 ± 0.14 | | CHECKED BY DATE | | molex MATERIAL NO. DOCUMENT NO. SHEET NO. SEE CHART SD-43025-001 1 OF 1 | | | | | |
| 1 PLACE ± 0.35 ± --- | | SSOUSEK 2008/01/25 | | | | | | | |
| 0 PLACE ± --- ± --- | | APPROVED BY DATE | | THIS DRAWING CONTAINS INFORMATION THAT IS PROPRIETARY TO MOLEX INCORPORATED AND SHOULD NOT BE USED WITHOUT WRITTEN PERMISSION | | | | | |
| | | FSMITH 2008/02/02 | | | | | | | |
| DRAFT WHERE APPLICABLE MUST REMAIN WITHIN DIMENSIONS | | SIZE D | | | | | | | |

NOTES:

- 1) OVERMOLDED MATERIAL SHOULD NOT ENCAPSULATE THE TERMINAL IN AND AROUND THE WIRE CRIMP AREA.
- 2) TERMINALS MUST BE CENTERED AND PERPENDICULAR INSIDE THE RECEPTACLE HOUSING BEFORE AND AFTER OVERMOLDING.
- 3) DEVICE USED TO CENTER TERMINALS MUST NOT EXCEED .020 SQUARE IN ORDER TO PREVENT TERMINAL DEFORMATION.
- 4) OVERMOLD TOOLING MUST NOT DAMAGE INTERNAL OR EXTERNAL FEATURES OF CABLE ASSEMBLY.
- 5) THE OVERMOLDING TEMPERATURES DURING PROCESSING MUST NOT EXCEED 320°F
- 6) REMOVAL OF CABLE ASSEMBLY FROM THE TOOLING MUST NOT IN ANY WAY DAMAGE THE SUPPLIED COMPONENTS.
- 7) MOLEX IS RESPONSIBLE ONLY FOR COMPONENTS SUPPLIED TO THE OVERMOLDER, BUT NOT FOR NONCONFORMANCES INDUCED DURING THE OVERMOLDING PROCESS, SUCH AS OVERMOLD MATERIAL IN THE CONTACT AREA, TERMINALS THAT ARE EITHER OUT OF CENTER OR LACK OF TERMINAL MOBILITY AFTER BEING OVERMOLDED, AND ANY DEFORMATION TO TERMINALS OR HOUSINGS IN GENERAL.

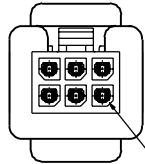
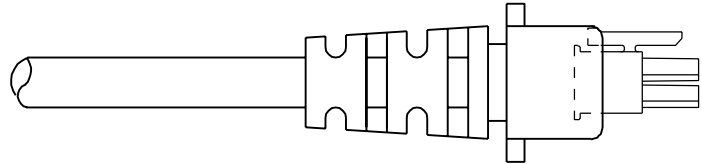

TERMINALS MUST BE CENTERED IN RECEPTACLE PRIOR TO OVERMOLDING

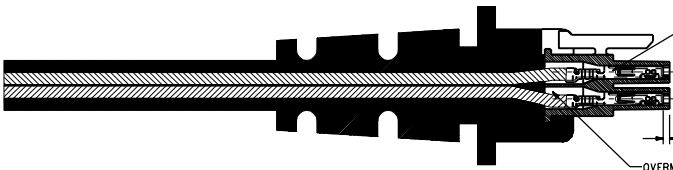
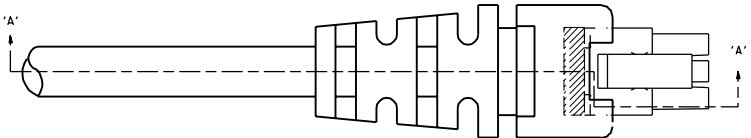

TERMINALS SHOULD BE FULLY SEATED (APPROXIMATELY .030/(0.76) FROM TOP OF SILOS) BEFORE OVERMOLDING

.030 (0.76) REF.

OVERMOLD MATERIAL SHOULD NOT PROCEED PASS WIRE CRIMP

SECTION 'A-A'

| | |
|---|--------------------------------------|
| B | REVISED PER EEM 14-0172 01/31/95 BAP |
| A | REVISED PER EEM 14-0138 06/23/94 BAP |

| | | | | | | | | | | | | | | | | | | | | | | | |
|---|----|---|----|---|---|---|---|---|---|---|----|----|----|----|----|----|----|----|----|----|----|--|--|
| DIMS: SHOWN METRIC UNITS | | REVISE ONLY ON CAD SYSTEM | | | | | | | | | | | | | | | | | | | | | |
| <table border="1"> <tr> <td>1</td> <td>2</td> <td>3</td> <td>4</td> </tr> <tr> <td>5</td> <td>6</td> <td>7</td> <td>8</td> </tr> <tr> <td>9</td> <td>10</td> <td>11</td> <td>12</td> </tr> <tr> <td>13</td> <td>14</td> <td>15</td> <td>16</td> </tr> <tr> <td>17</td> <td>18</td> <td>19</td> <td>20</td> </tr> </table> | | 1 | 2 | 3 | 4 | 5 | 6 | 7 | 8 | 9 | 10 | 11 | 12 | 13 | 14 | 15 | 16 | 17 | 18 | 19 | 20 | TITLE: MICRO-FIT (3.0) OVERMOLDING SPECIFICATIONS PART NO: NONE SCALE: 4:1 | |
| 1 | 2 | 3 | 4 | | | | | | | | | | | | | | | | | | | | |
| 5 | 6 | 7 | 8 | | | | | | | | | | | | | | | | | | | | |
| 9 | 10 | 11 | 12 | | | | | | | | | | | | | | | | | | | | |
| 13 | 14 | 15 | 16 | | | | | | | | | | | | | | | | | | | | |
| 17 | 18 | 19 | 20 | | | | | | | | | | | | | | | | | | | | |
| MOLEX INCORPORATED 1000 W. CALIFORNIA AVENUE MOLEX INCORPORATED | | SHEET NO: 1 OF 1 DATE: 06/23/94 REV: 1000 | | | | | | | | | | | | | | | | | | | | | |