

10 9 8 7 6 5 4 3 2 1

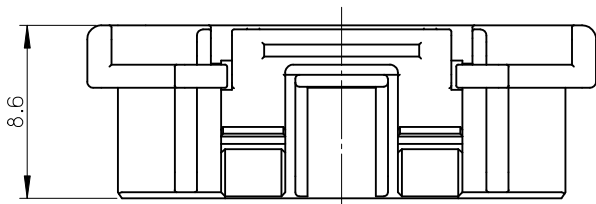

2.3極形状 (1ロック)
FIGURE OF 2.3 CIRCUIT (1 LOCK)

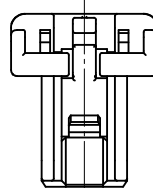

4,5極形状 (1ロック)
FIGURE OF 4.5 CIRCUIT (1 LOCK)

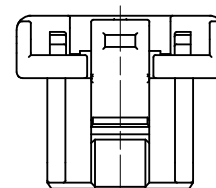

6極形状 (2ロック)
FIGURE OF 6 CIRCUIT (2 LOCK)

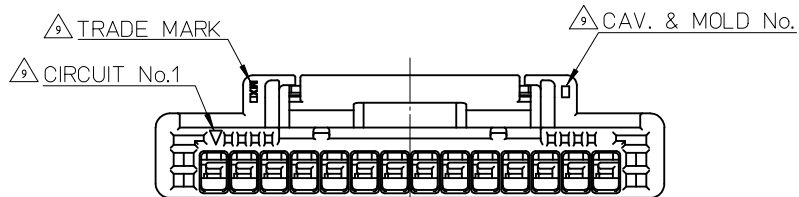
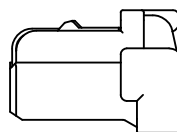
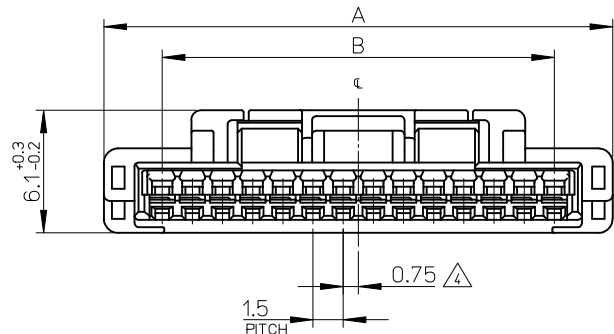
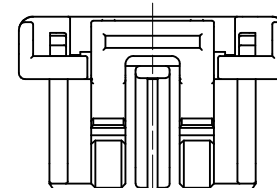

NOTES

1. 材料 MATERIAL
ハウジング : PBT , UL94-V0
HOUSING : PBT , UL94-V0
2. 嵌合相手 : 502584,502585,503159,503175,503339,503340,503395 シリーズ
MATE WITH : 502584,502585,503159,503175,503339,503340,503395 SERIES.
3. 適合ターミナル : 502579, 503429 シリーズ
APPLICABLE TERMINAL : 502579, 503429 SERIES.

△ 極数/2=偶数極の場合に適用
APPLY FOR (CIRCUIT/2)=EVEN

△ 注文番号
ORDER No.

502578 - * * * * *



6. 本製品のプラスチック部に黒点・白点等が確認される場合や色合いが異なる場合がありますが、製品性能に影響はありません。
THERE IS NO INFLUENCE IN THE PRODUCT PERFORMANCE THOUGH THE BLACK AND WHITE SPOT ETC. MIGHT BE CONFIRMED TO THE PLASTIC PART OF THIS PRODUCT AND THE SHADE MIGHT BE DIFFERENT.
7. アプリケーション仕様書(コネクタ取扱説明書) : AS-502578-001, AS-502578-002
APPLICATION SPECIFICATIONS (CONNECTOR MANUAL): AS-502578-001, AS-502578-002
8. 製品仕様書 : PS-502584-001
Product specification: PS-502584-001

△ トレードマーク : MX プラス1文字の製造工場を示すアルファベットにて表示。但し"J"は JAPAN を示す。(例 MXJ)

キャビティ番号 : 1桁から2桁の数字にて表示。
金型番号 : アルファベット1文字にて表示。

FORMED BY MX AND 1 MORE LETTER OF ALPHABET WHICH MEAN THE MANUFACTORY. BUT "J" MEANS JAPAN. (TO TRADE MARK) (e.g. MXJ)
AND BY 1 - 2 DIGIT NUMBER (TO CAVITY No.)
AND BY 1 LETTER OF ALPHABET (TO MOLD No.)

10. ELV 及び RoHS 適合品
ELV AND RoHS COMPLIANT

No.	COLOR	CIRCUIT
00	ベージュ BEIGE	2~15
01	黒 BLACK	
02	赤 RED	
03	黄 YELLOW	
04	青 BLUE	
05	桃 PINK	
06	緑 GREEN	
07	茶 BROWN	
08	橙 ORANGE	
09	紫 VIOLET	3~5
11	灰 GRAY	
16	黄緑 YELLOWISH GREEN	
14	水 PALE BLUE	2~5

21	26.8	502578-15**	15
19.5	25.3	-14**	14
18	23.8	-13**	13
16.5	22.3	-12**	12
15	20.8	-11**	11
13.5	19.3	-10**	10
12	17.8	-09**	9
10.5	16.3	-08**	8
9	14.8	-07**	7
7.5	13.3	-06**	6
6	11.8	-05**	5
4.5	10.3	-04**	4
3	8.8	-03**	3
1.5	7.3	502578-02**	2
B	A	PLASTIC BAG ORDER No.	CIRCUIT No.

REVISED		GENERAL TOLERANCES (UNLESS SPECIFIED)		DIMENSION STYLE		SCALE		DESIGN UNITS		THIRD ANGLE PROJECTION	
EC NO.	DATE			MM ONLY		4:1		METRIC			
J2012-1450	2012/06/06	10 UNDER ±0.2		DRAWN BY N. ITO		DATE '07/07/09		TITLE		1.5MM W/B CONN. SINGLE PLUG HOUSING	
DRWN:KMATSUYAMA	2012/06/06	10 OVER 30 UNDER ±0.25		CHECKED BY K. ASAKAWA		DATE '07/07/10		MATERIAL NO.		DOCUMENT NO. SD-502578-001	
CHKD:KASAKAWA	2012/06/06	30 OVER ±0.3		APPROVED BY Y. ITO		DATE '07/07/10		SHEET NO.		1 OF 1	
APPR:Y01ITO	2012/06/08	ANGULAR ±3 °		DRAFT WHERE APPLICABLE MUST REMAIN WITHIN DIMENSIONS		SIZE A3		THIS DRAWING CONTAINS INFORMATION THAT IS PROPRIETARY TO MOLEX INCORPORATED AND SHOULD NOT BE USED WITHOUT WRITTEN PERMISSION			