



PRODUCT SPECIFICATION

2MM DUAL ROW VERTICAL RECEPTACLE ASSEMBLIES

1.0 SCOPE

This specification covers the mechanical, electrical and environmental performance of the .079" X 0.79" (2mm X 2mm) grid dual row vertical receptacle connector series numbers 79107, 79108 & 79109. This connector series is designed for through hole, flat flex cable and surface mount applications respectively as described in Para 2.1. Mating connectors shall have 0.20" (0.51mm square) or round posts whose axes are perpendicular to the plane of the PCB to which the 2mm series receptacles are soldered.

2.0 PRODUCT DESCRIPTION

The dual row vertical receptacle series is designed to connect; (1) PC board to PC board in parallel, (2) PC board to PC board perpendicular. The connector utilizes a dual beam female terminal designed to provide east-west mating and early entry mating when mated from the top. This connector series is available in a range of circuit sizes from 4 circuits (2 X 2) through 50 circuits (2 X 25) in 2 circuit increments.

2.1 PRODUCT NAME AND PART NUMBERS

The types covered in this specification are as follows:-

Series numbers	Product Description
79107	Vertical Receptacle with 0.118" (3.00mm) and .075"(1.91mm) long PC tails. Receptacle has PC tails for solder termination to either a 0.063" (1.57mm) or 0.031" (0.79mm) nominal thick PC board with 0.025" (0.64mm) minimum diameter holes (See Figure 1). The PC tails have a tapered lead -in for ease of insertion into the PC board.
79108	Vertical receptacle with 0.050" (1.27mm) long PC tails for FFC application.
79109	Vertical Receptacle with gullwing surface mount tails for FFC or FPC application. Surface mount version with pegs is also designed to accommodate bottom entry mating through a PC board. See Figure 2 for suggested PC board layout. Performance of bottom entry is expected to be similar to top entry; however data is not currently available.

2.2 Dimensions, Materials, Platings and Markings

Please refer to the appropriate Sales Drawings for information on dimensions and markings.

2.3 Safety Agency Approval

UL File: E29179

CSA File: LR19980

6/21/2011RE	ECR/ECN INFORMATION:	TITLE:	SHEET No.
B2	EC No: S2011-1026	<u>2MM DUAL ROW VERTICAL RECEPTACLE</u>	1 of 18
	DATE: 2011 / 06 / 03		
DOCUMENT NUMBER: PS-79107		CREATED / REVISED BY: SKANG 2011/06/03	CHECKED BY: ATSEE 2011/06/21
		APPROVED BY: MLONG 2011/06/21	



PRODUCT SPECIFICATION

3.0 APPLICATION DOCUMENTS AND SPECIFICATIONS

See the Sales Drawings and the other sections of this Specification for the necessary referenced Documents and Specification.

3.1	MIL-STD-202	Test methods for electronics and electronics and electrical component parts.
3.2	MIL-STD-1344	Test methods for electrical connectors.
3.3	ASTM-B103	Alloy 521.
3.4	QQ-N-290	Nickel plating.
3.5	MIL-G-45204	Gold plating.
3.6	MIL-T-10727	Tin plating.
3.7	MIL-M-24519	Molding plastics.
3.8	UL-94	Tests for flammability of plastic materials.
3.9	ES-88	Molex Finish Specification.

4.0 RATING

4.1 VOLTAGE: 125 Volts DC/AC (RMS) Max.

4.2 CURRENT: 1 Amps DC/AC (RMS) Max.

4.3 TEMPERATURE:

Operating Temperature: - 55°C to +125°C

Non-operating Temperature: - 55°C to +125°C

5.0 PERFORMANCE

5.1 ELECTRICAL PERFORMANCE

ITEM	DESCRIPTION	TEST CONDITION AND REQUIREMENT
5.1.1	Insulation Resistance	Insulation resistance when tested per MIL-STD-202, Method 302, Condition B at ambient shall be as follows: 1. 5000 mega ohms minimum initially 2. 1000 mega ohms minimum following humidity.
5.1.2	Dielectric Withstanding Voltage	Dielectric withstanding voltage shall be 500 VAC minimum at sea level. There shall be no breakdown or flash-over between adjacent contacts and leakage current shall not exceed 5.0 milliamps when unmated connectors are tested per MIL-STD-202, Method 301.
5.1.3	Contact Resistance (Low level)	Defined as the normal bulk resistance plus constriction resistance. The maximum value shall not exceed 15 milliohms total with a maximum change of 10 milliohms from initial following all stress tests. The method of measurement shall be per MIL-STD-1344A, Method 3002.1.
5.1.4	Current Rating	1.9 Amp DC or AC RMS per contact with no more than 30°C temperature rise above ambient. All contacts wired in series
		1.0 Amp DC or AC RMS per contact at 70°C with 30°C maximum temperature rise .All contacts wired in series.

6/21/2011RE	ECR/ECN INFORMATION:	TITLE:	SHEET No.
B2	EC No: S2011-1026	<u>2MM DUAL ROW VERTICAL RECEPTACLE</u>	2 of 18
	DATE: 2011 / 06 / 03		
DOCUMENT NUMBER: PS-79107		CREATED / REVISED BY: SKANG 2011/06/03	CHECKED BY: ATSEE 2011/06/21
		APPROVED BY: MLONG 2011/06/21	



PRODUCT SPECIFICATION

5.1.5	Current Cycling	Subject the mated connectors to 75% of the current necessary to yield a 30°C temperature rise (as found in para.5.1.4) in cycles of 45 minutes on and 15 minutes off for 240 hours after which the conditions of Para 5.1.3 are met.
--------------	------------------------	--

5.2 MECHANICAL PERFORMANCE

ITEM	DESCRIPTION	TEST METHODS AND REQUIREMENT
5.2.1	Mating Force- Entire connector	The maximum force to mate a connector pair shall be 10 oz. multiplied by the number of positions, excluding hardware, when cycled per MIL-STD-1344, Method 2013 for the following conditions: 1. Ambient conditions. 2. Non rigid fixturing of connector pairs. 3. 10 inches /minute max. Cycling rate. 4. 50 mate/ unmate cycles.
5.2.2	Individual Insertion/ withdrawal force	The force to insert and withdraw a steel gauge pin shall be 8 ounces maximum and 1.5 ounces minimum respectively , excluding hardware, when tested per MIL-STD-1344, Method 2014 for the following conditions: 1. Polished steel gauge pins per Fig 3. 2. Insertion depth to be 0.60" from the point at which gauge makes contact with the terminal beams. 3. Non rigid fixturing shall be used. 4. 3 cycles.
5.2.2	Normal Force	The minimum normal "force" shall be 100 grams following thermal aging per para.9.4.1 and 50 mating / unmating cycles per Para. 8.4.1 When tested at minimum deflection as caused by a 0.020" +/- .001" square pin. Measurement shall be taken in a manner simulating actual use.
5.2.3	Durability	For the 15 micro inch gold over 50 micro- inch nickel plating option, the connector shall meet the requirements of paras.5.1.3 and 5.2.2 after the following sequential conditioning: 1. 50 mate/ unmate cycles. 2. Seventeen hours of Flowers of Sulfur per Molex test procedure.
5.2.4	Terminal strength	Solder tails shall withstand two hand bending cycles per MIL-STD-202, Method 211A, condition "B" with no evidence of breaking or cracking of the base metal at 20X magnification.
5.2.5	Solderability	All terminals shall have 95% coverage per the requirements of MIL-STD-202, Method 208 with conditions as follows: 1. Solder Composition: 60/40 tin-lead per QQ-S-571 Type S. 2. Solder Temperature: 230°C +/-5°C 3. Flux Type: Mildly activated, type RMA per MIL-F-14256. 4. Depth of Immersion: 0.080" (3.0mm)
5.2.6	Housing Retention	A tensile force is applied at a rate of 1 inch per minute to the housing perpendicular to the test board. The force at which the housing separates from the terminals is divided by the circuit size and recorded. This force to be 8 ounces minimum per terminal.

6/21/2011RE B2	ECR/ECN INFORMATION: EC No: S2011-1026 DATE: 2011 / 06 / 03	TITLE: <u>2MM DUAL ROW VERTICAL RECEPTACLE</u>	SHEET No. 3 of 18
DOCUMENT NUMBER: PS-79107		CREATED / REVISED BY: SKANG 2011/06/03	CHECKED BY: ATSEE 2011/06/21
APPROVED BY: MLONG 2011/06/21			



PRODUCT SPECIFICATION

5.2.7	Individual Tensile (Surface Mount Only)	A tensile force perpendicular to the test board is applied at a rate of 1 inch per minute to individual surface mount terminal with housings. The force at which the terminal separates from the board is to be greater than 3 lbs.
5.2.8	Full connector Tensile (Surface mount Only)	A tensile force perpendicular to the board is applied at a rate of 1 inch per minute to the entire connector. The force at which the housing separates from the terminals should be greater than 1 lb. per terminal pair.
5.2.9	Shear Test (Surface Mount Only)	A shear force parallel to the board and perpendicular to the lay of the connector is applied at a rate of 1 inch per minute. The force at which the connector distorts or shears off the board should be greater than 2 lbs. per terminal pair. See Fig 4.
5.2.10	Solder Joint Fatigue (Surface Mount Only)	There shall be no evidence of physical damage and contact resistance shall meet the condition of Para. 5.1.3 and there shall be no loss of electrical continuity greater than 1 microsecond after the following tests: <ol style="list-style-type: none"> 1. Tension: Subject the test board, as shown in Fig. 5, to .060" deflection perpendicular to the lay of the connector for 200 cycles. Repeat the above on a new sample except deflect parallel to the lay of the connector as show in Fig.6. 2. Compression: Subject the test board as shown in Fig.7 to .060" deflection perpendicular to the lay of the connector for 200 cycles. Repeat the above on a new sample except deflect parallel to the lay of the connector as shown in Fig.8.

5.3 ENVIRONMENTAL PERFORMANCE

ITEM	DESCRIPTION	TEST METHODS AND REQUIREMENT
5.3.1	Resistance To Cleaning Solvents	Any markings shall remain legible and no damage or deterioration of the connector shall occur when tested per MIL-STD-202, Method 215. The following solvents shall be used: <ol style="list-style-type: none"> 1. I-I-I Trichloroethane 2. Freon TMS and TMC
5.3.2	Temperatures	The product is designed to operate at -55°C to 125°C continuous and withstand +219°C during vapor soldering without any deterioration of performance or physical damage.
5.3.3	Thermal shock	There shall be no evidence of any physical damage. Connectors shall meet the dimensional requirements of the product drawings and contact resistance of para. 5.1.3 When tested per MIL-STD-202, Method 107, Condition A-1.
5.3.4	Temperature Life	The requirements of the Para. 5.1.3 and 5.2.2 shall be met following thermal life per MIL-STD-202, Method 108, Test Condition "C" (500 hours at 105°C). Connectors shall remain in initial mated or unmated condition throughout thermal exposure.
5.3.5	Humidity (Cyclical)	There shall be no evidence of physical damage, or discoloration and the requirements of Paras. 5.1.1, 5.1.2 and 5.1.3 shall be met following testing per MIL-STD-1344, Method 1002, Type II; 96 hours (omit steps 7A and 7B). The connectors shall be mated during exposure.

6/21/2011RE	ECR/ECN INFORMATION:	TITLE:	SHEET No.
B2	EC No: S2011-1026	<u>2MM DUAL ROW VERTICAL RECEPTACLE</u>	4 of 18
	DATE: 2011 / 06 / 03		
DOCUMENT NUMBER: PS-79107		CREATED / REVISED BY: SKANG 2011/06/03	CHECKED BY: ATSEE 2011/06/21
		APPROVED BY: MLONG 2011/06/21	

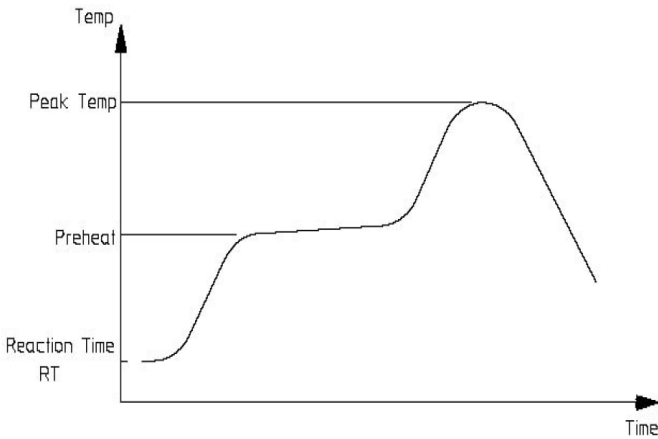

PRODUCT SPECIFICATION

5.3.6	Humidity (Steady State)	There shall be no evidence of physical damage, discoloration, or corrosion and the requirements of Para 5.1.1, 5.1.2 and 5.1.3 shall be met following testing per MIL-STD-202 Method 103, Condition A. No polarizing voltage measurement shall be taken.
5.3.7	Resistance To Solder Heat	<p>There shall be no evidence of any physical damage and connectors shall meet the dimensional requirements of the product drawings following:</p> <ol style="list-style-type: none"> 1. MIL-STD-202, Method 210, Test Condition C (260°C 10 seconds). <p style="text-align: center;"><u>Reflow Temperature Profile</u></p>  <p>The graph shows a temperature profile over time. The y-axis is labeled 'Temp' and the x-axis is 'Time'. The curve starts at 'Reaction Time RT', rises to a 'Preheat' level, then reaches a 'Peak Temp' before cooling down.</p> <ol style="list-style-type: none"> 2. Standard wave soldering process.
5.3.8	Vibration	There shall be no evidence of any physical damage, loosening of parts or loss of electrical continuity greater than 1.0 microsecond when mated connectors are tested per MIL-STD-202, Method 204, Test Condition A.
5.3.9	Mechanical shock	<p>There shall be no evidence of any physical damage or loosening of parts. Nor shall there be any interruption of electrical continuity per MIL-STD-202F, Method 213B, condition A: longer than one microsecond when tested</p> <ol style="list-style-type: none"> 1. ½ Sine Wave. 2. 50G, 11 millisecond pulse. 3. 3 shocks each along 3 mutually perpendicular axis, 18 shocks total.
5.3.10	Corrosive Atmosphere	Connectors shall meet the requirements of Para. 5.1.3 When exposed to Flowers of Sulfur following conditioning per Para.5.2.3.

6.0 PACKAGING

Parts shall be packaged to protect against damage during handling, transit and storage. Unless otherwise specified, product will be packaged in tubes per packing specifications PK-70783-0180 and PK-70783-0217.

6/21/2011RE B2	ECR/ECN INFORMATION: EC No: S2011-1026 DATE: 2011 / 06 / 03	TITLE: <u>2MM DUAL ROW VERTICAL RECEPTACLE</u>	SHEET No. 5 of 18	
DOCUMENT NUMBER: PS-79107		CREATED / REVISED BY: SKANG 2011/06/03	CHECKED BY: ATSEE 2011/06/21	APPROVED BY: MLONG 2011/06/21



PRODUCT SPECIFICATION

7.0 OTHER INFORMATION

8.1 General Requirements

8.1.1 Design construction and physical dimensions shall be as specified on the 79107, 79108 and 79109 product drawings.

8.1.2 Materials

- 1) Housing: 94V-0 glass filled liquid crystal polymer. Oxygen index greater than 28. Color: Black
- 2) Terminal: Phosphor bronzer, per ASTM-B103.

8.1.3 Plating

- 1) All tin finishes to be per MIL-T-10727B and MIL-P-81728A. All gold finish to be per MIL-G-45204B, type II, Grade C, Class I. All nickel finishes to be per QQ-N-290, Class II. Also see Molex plating standard ES-88.
- 2) plating code 574 (Per Molex ES-88): 0.000030" (0.00076mm) min. gold plate in contact area with 0.000075" (0.00190mm) min. tin/lead (90/10) plate in tail area over 0.000050" (0.00127mm) min nickel plate overall.
- 3) plating Code 571 (Per Molex ES-88): 0.000015" (0.000038mm) min. gold plate in contract are with 0.00075" (0.00190mm) min. tin/lead (90/10) plate in tail area over 0.00050" (0.00127mm) min. nickelplate overall.

8.1.4 Recommended Printed Circuit Board Specification

- 1) PCB thickness: 0.062" +/- 0.07" (1.57mm +/-0.18) and 0.31 +/- 0.05 (0.79mm +/- 0.13).
- 2) Recommended PCB hole/ SMT land pattern: See Figure 2.

8.1.5 Recommended mating pin lengths:

- 1) For top entry mating, the recommended mating pin length is 0.120" to 0.170" (3.05mm to 4.30mm).
- 2) For bottom entry mating, the recommended mating pin lengths are 0.240" to 0.255" (6.10mm to 6.50mm) for a 0.047" PCB and 0.255" to 0.270" (6.50mm to 6.85mm) for a 0.62" PCB. This dimension is measured from the bottom entry PC board, not from the insulator on the mating header.

8.1.6 Sides of square pins must be parallel with the axis of the row within 5 (+/-) degrees.

9.0 Quality Assurance Provisions

Material inspection shall consist of certification, supported by verifying data. Mechanical, chemical and electrical testing shall be done on a random basis.

6/21/2011RE	ECR/ECN INFORMATION:	TITLE:	SHEET No.
B2	EC No: S2011-1026	<u>2MM DUAL ROW VERTICAL RECEPTACLE</u>	6 of 18
	DATE: 2011 / 06 / 03		
DOCUMENT NUMBER: PS-79107		CREATED / REVISED BY: SKANG 2011/06/03	CHECKED BY: ATSEE 2011/06/21
		APPROVED BY: MLONG 2011/06/21	



PRODUCT SPECIFICATION

10. Qualification Requirement

10.1	Ambient conditions for qualification shall be per Para. 4.3
10.2	Qualification testing shall be performed on samples taken from production lots.
10.3	<p>Samples grouping</p> <ol style="list-style-type: none"> 1. Test group I shall consist of (20) A-79107-0024(50 circuit, 15u" gold, through hole), (2) A-79109-0024 (50 ckt, 15u" gold, surface mount) connectors, and (22) 87089-5013 headers. 2. Test group II & III shall consist of (16) A-79107-0024, (2) A-79109-0024 connectors, and (18)87089-5013 headers each. 3. Test group IV shall consist of (4) A-79107-0024 connectors. 4. Test group V shall consist of (18) A-79107-0024 connectors mounted and loose as needed. 5. Test group VI shall consist of (24) A-79109-0024 and (26) A-79109-0260 connectors.
10.4	<p>Samples preparation</p> <ol style="list-style-type: none"> 1. Through Hole: Four A- 79107-0024 connectors are to be wave soldered to each through hole PC board. 2. Surface Mount: Solder paste consisting of metal alloy 63/37 eutectic tin-lead and a rosin mildly activated (RMA) flux is to be stenciled onto the solder lands of the surface mount boards in a layer no thicker that .010"(0.25mm). The surface mount connectors will then be vapor phase reflowed to the PC boards in approved equipment. Flourinert liquid FC-70 is to be used with a primary vapor zone reflow time of 15 seconds and a secondary vapor zone dwell time of 45 seconds. Each test board shall be cleaned immediately in a vapor degreaser and cleaned with Freon TMS for at least 3 minutes.
10.5	Qualification testing shall be performed per the test sequence shown Figs. 9-15

6/21/2011RE	ECR/ECN INFORMATION:	TITLE:	SHEET No.
B2	EC No: S2011-1026	<u>2MM DUAL ROW VERTICAL RECEPTACLE</u>	7 of 18
	DATE: 2011 / 06 / 03		
DOCUMENT NUMBER:	CREATED / REVISED BY:	CHECKED BY:	APPROVED BY:
PS-79107	SKANG 2011/06/03	ATSEE 2011/06/21	MLONG 2011/06/21



PRODUCT SPECIFICATION

11.0 APPENDIX

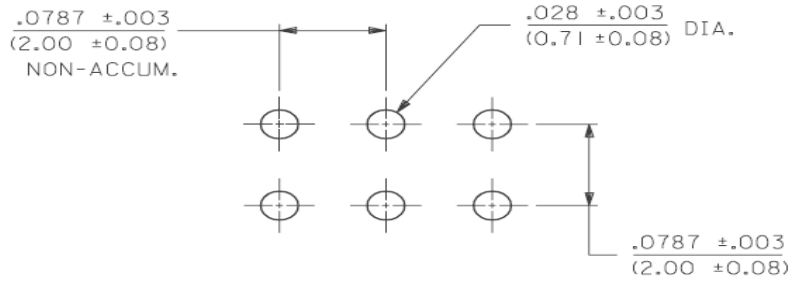
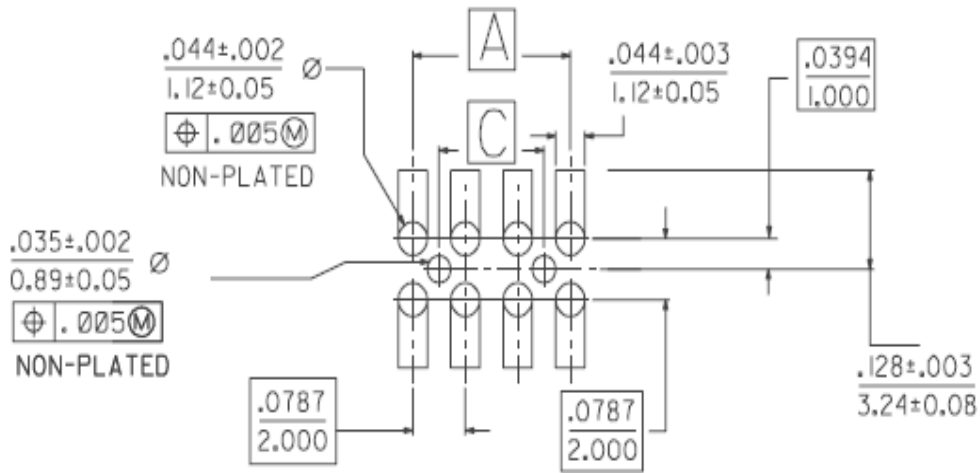

FIGURE 1
RECOMMENDED P.C. BOARD HOLE LAYOUT

6/21/2011RE	ECR/ECN INFORMATION:	TITLE:	SHEET No.
B2	EC No: S2011-1026 DATE: 2011 / 06 / 03	<u>2MM DUAL ROW VERTICAL RECEPTACLE</u>	8 of 18
DOCUMENT NUMBER:	CREATED / REVISED BY:	CHECKED BY:	APPROVED BY:
PS-79107	SKANG 2011/06/03	ATSEE 2011/06/21	MLONG 2011/06/21



PRODUCT SPECIFICATION



BOTTOM ENTRY LAND LAYOUT

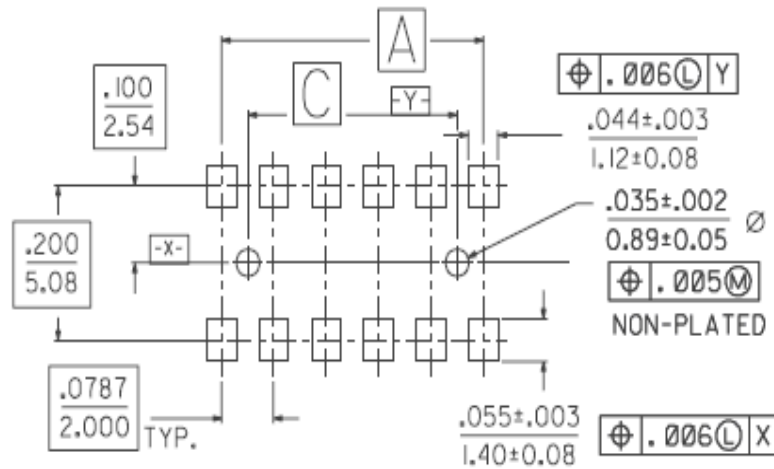

SMT PC BOARD LAND LAYOUT

FIGURE 2
RECOMMENDED P.C. BOARD LAND LAYOUTS

6/21/2011RE	ECR/ECN INFORMATION:	TITLE:	SHEET No.
B2	EC No: S2011-1026	2MM DUAL ROW VERTICAL RECEPTACLE	9 of 18
	DATE: 2011 / 06 / 03		
DOCUMENT NUMBER: PS-79107	CREATED / REVISED BY: SKANG 2011/06/03	CHECKED BY: ATSEE 2011/06/21	APPROVED BY: MLONG 2011/06/21



PRODUCT SPECIFICATION

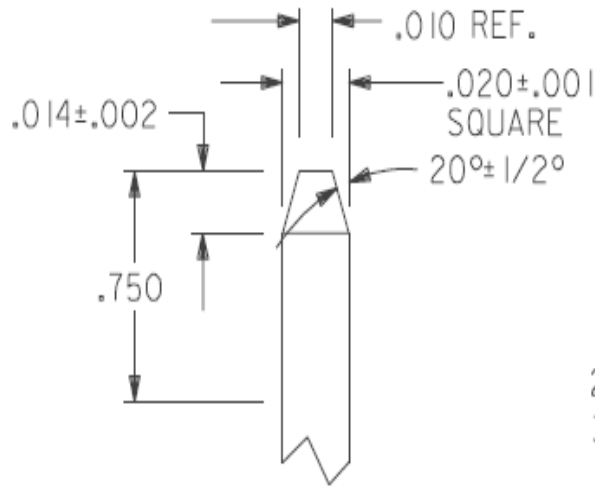

NOTES:

1. MATERIAL: TOOL STEEL.
2. FINISH: 4 MICROINCH MAX.
3. $.020 \pm .001$ MUST BE HELD OVER $.750$ " DIMENSION.

FIGURE 3
GAUGE PIN

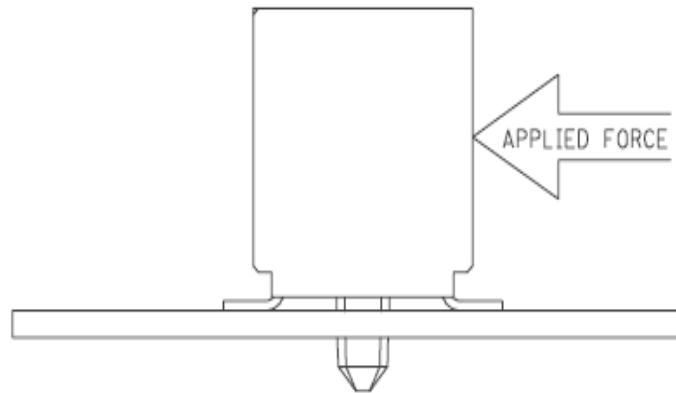

FIGURE 4
PERPENDICULAR SHEAR

6/21/2011RE	ECR/ECN INFORMATION:	TITLE:	SHEET No.
B2	EC No: S2011-1026 DATE: 2011 / 06 / 03	<u>2MM DUAL ROW VERTICAL RECEPTACLE</u>	10 of 18
DOCUMENT NUMBER: PS-79107	CREATED / REVISED BY: SKANG 2011/06/03	CHECKED BY: ATSEE 2011/06/21	APPROVED BY: MLONG 2011/06/21



PRODUCT SPECIFICATION

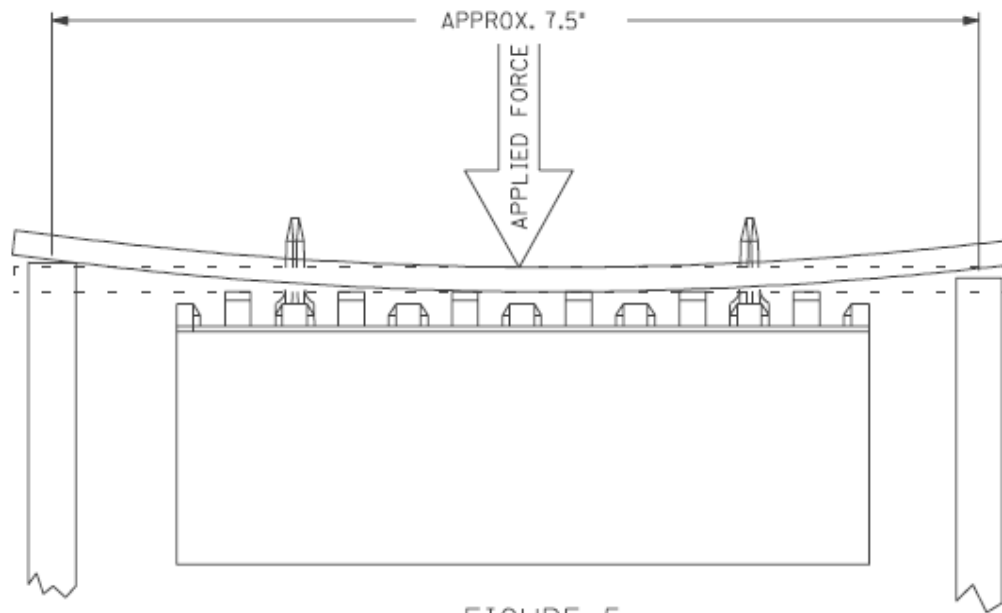

FIGURE 5
PERPENDICULAR SOLDER JOINT FATIGUE (TENSION)

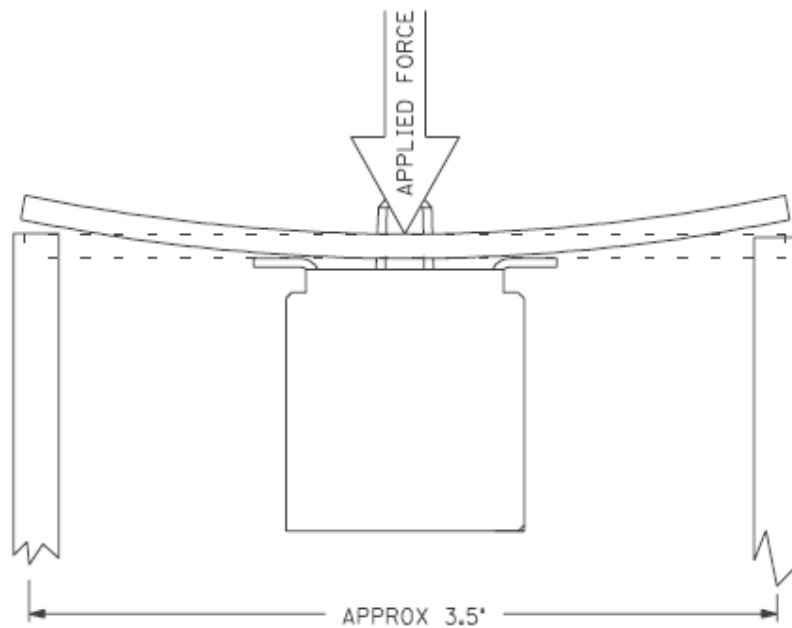

FIGURE 6
PARALLEL SOLDER JOINT FATIGUE (TENSION)

6/21/2011RE	ECR/ECN INFORMATION:	TITLE:	SHEET No.
B2	EC No: S2011-1026	<u>2MM DUAL ROW VERTICAL RECEPTACLE</u>	11 of 18
	DATE: 2011 / 06 / 03		
DOCUMENT NUMBER:	CREATED / REVISED BY:	CHECKED BY:	APPROVED BY:
PS-79107	SKANG 2011/06/03	ATSEE 2011/06/21	MLONG 2011/06/21



PRODUCT SPECIFICATION

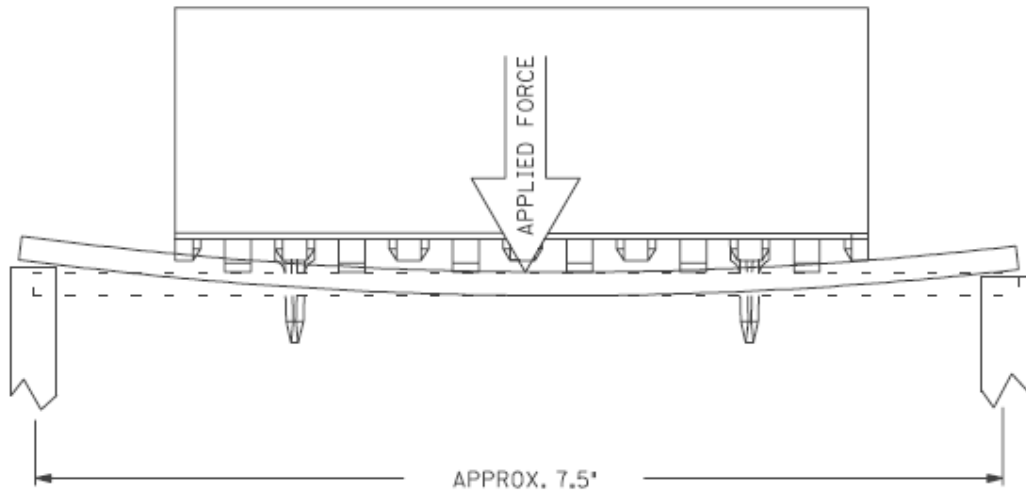

FIGURE 7

PERPENDICULAR SOLDER JOINT FATIGUE (COMPRESSION)

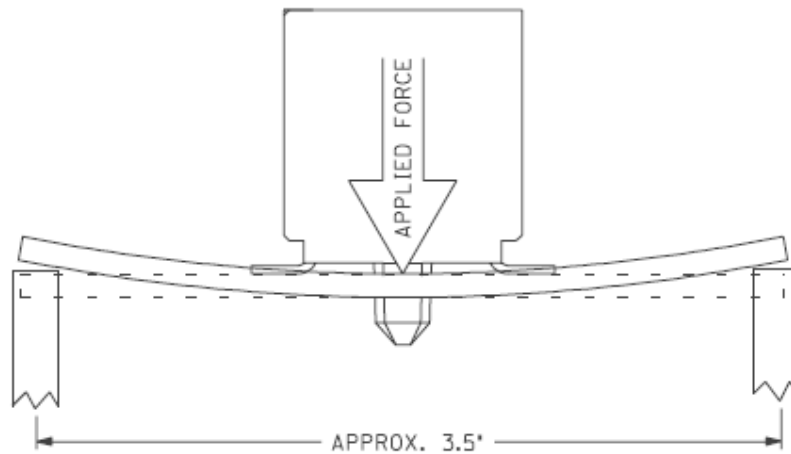

FIGURE 8

PARALLEL SOLDER JOINT FATIGUE (COMPRESSION)

6/21/2011RE	ECR/ECN INFORMATION:	TITLE:	SHEET No.
B2	EC No: S2011-1026	<u>2MM DUAL ROW VERTICAL RECEPTACLE</u>	12 of 18
	DATE: 2011 / 06 / 03		
DOCUMENT NUMBER: PS-79107	CREATED / REVISED BY: SKANG 2011/06/03	CHECKED BY: ATSEE 2011/06/21	APPROVED BY: MLONG 2011/06/21



PRODUCT SPECIFICATION

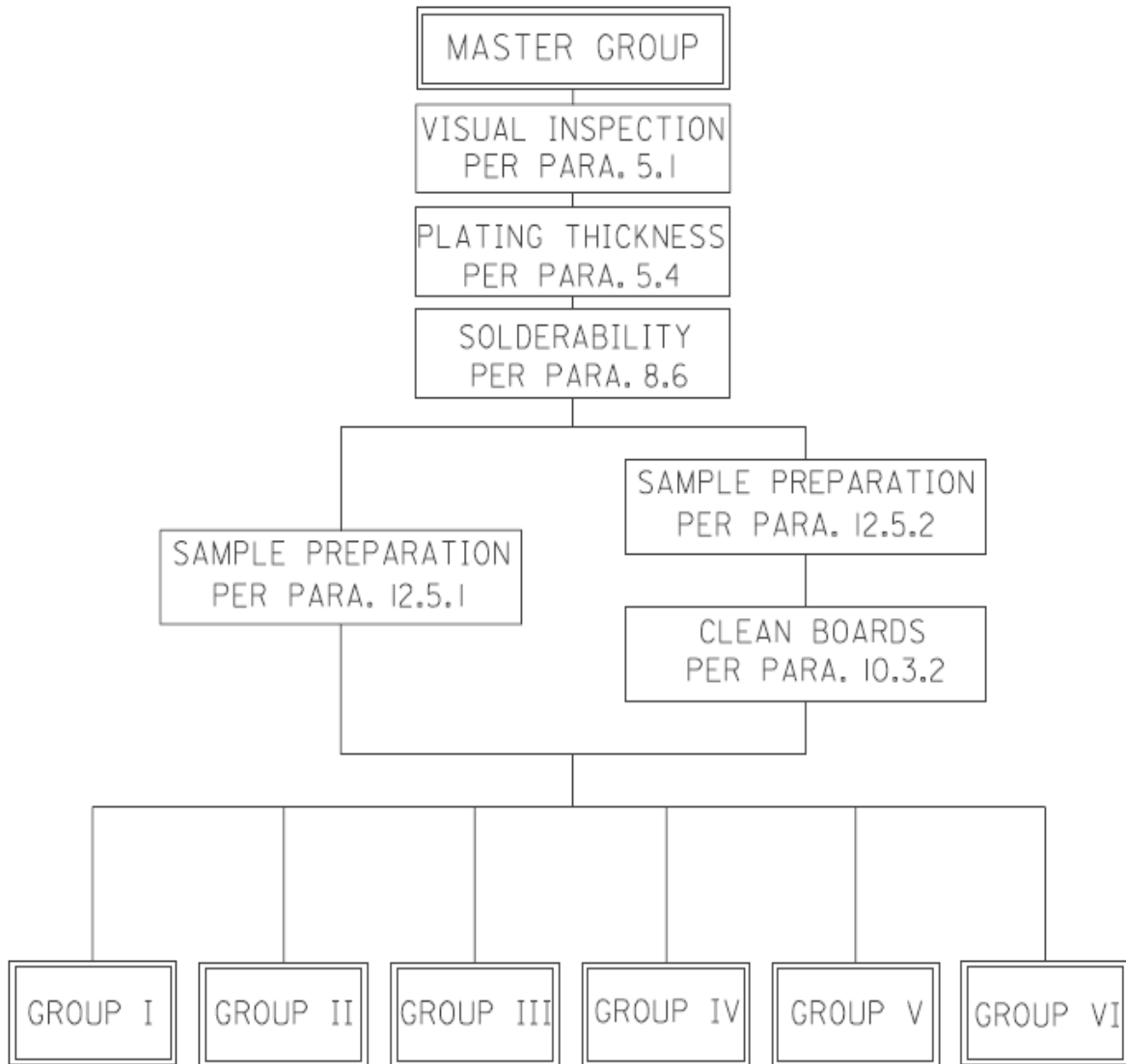

FIGURE 9

6/21/2011RE	ECR/ECN INFORMATION:	TITLE:	SHEET No.
B2	EC No: S2011-1026	<u>2MM DUAL ROW VERTICAL RECEPTACLE</u>	13 of 18
	DATE: 2011 / 06 / 03		
DOCUMENT NUMBER: PS-79107		CREATED / REVISED BY: SKANG 2011/06/03	CHECKED BY: ATSEE 2011/06/21
		APPROVED BY: MLONG 2011/06/21	



PRODUCT SPECIFICATION

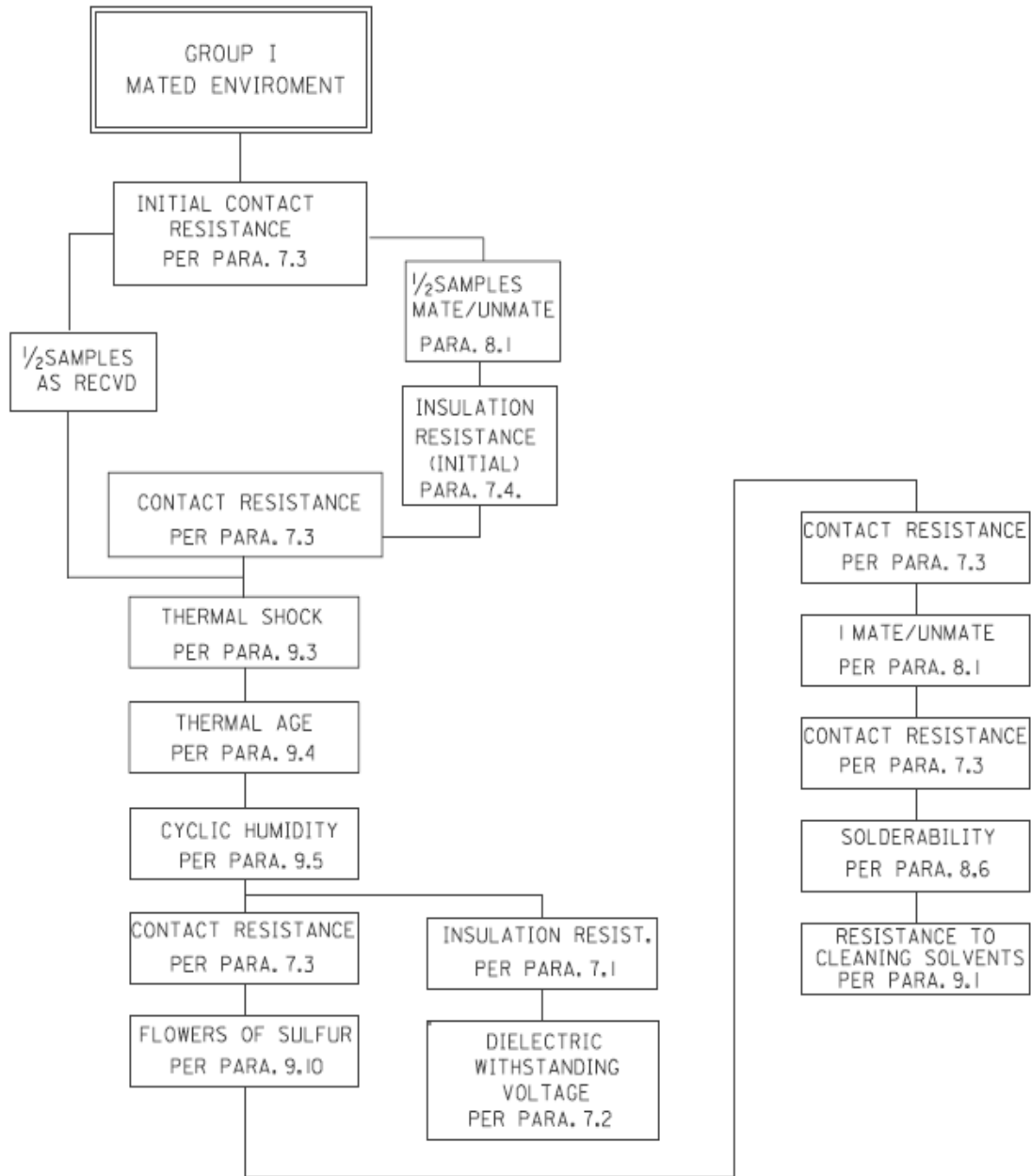

FIGURE 10

6/21/2011RE	ECR/ECN INFORMATION:	TITLE:	SHEET No.
B2	EC No: S2011-1026 DATE: 2011 / 06 / 03	2MM DUAL ROW VERTICAL RECEPTACLE	14 of 18
DOCUMENT NUMBER: PS-79107	CREATED / REVISED BY: SKANG 2011/06/03	CHECKED BY: ATSEE 2011/06/21	APPROVED BY: MLONG 2011/06/21



PRODUCT SPECIFICATION

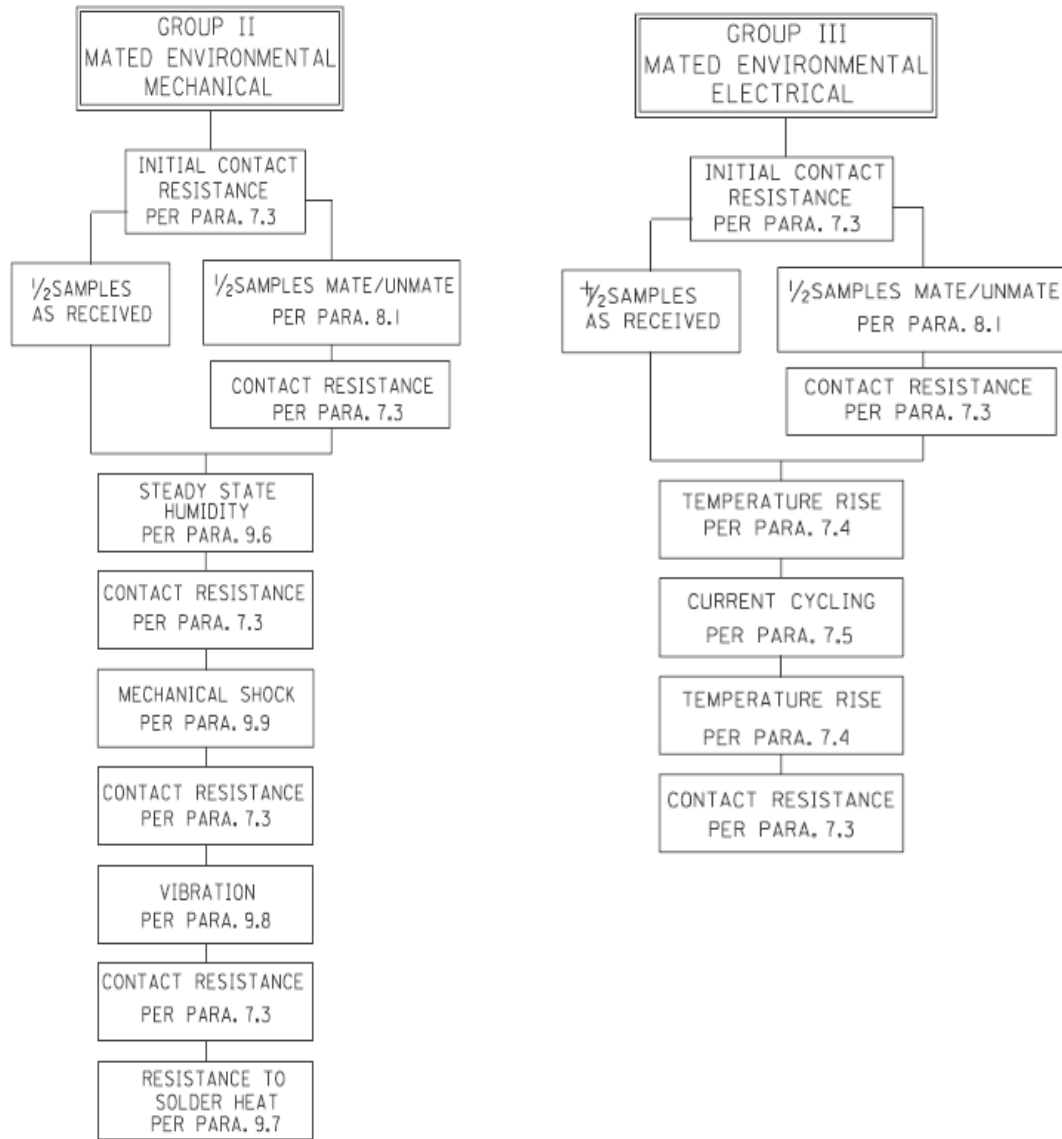

FIGURE 11

FIGURE 12

6/21/2011RE	ECR/ECN INFORMATION:	TITLE:	SHEET No.
B2	EC No: S2011-1026	2MM DUAL ROW VERTICAL RECEPTACLE	15 of 18
	DATE: 2011 / 06 / 03		
DOCUMENT NUMBER: PS-79107	CREATED / REVISED BY: SKANG 2011/06/03	CHECKED BY: ATSEE 2011/06/21	APPROVED BY: MLONG 2011/06/21



PRODUCT SPECIFICATION

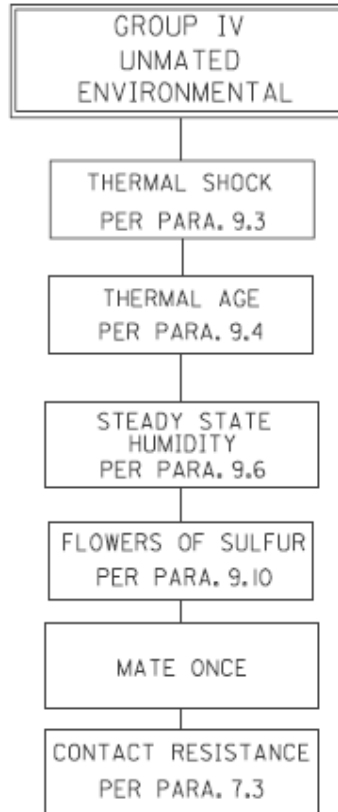

FIGURE 13

6/21/2011RE	ECR/ECN INFORMATION:	TITLE:	SHEET No.
B2	EC No: S2011-1026 DATE: 2011 / 06 / 03	<u>2MM DUAL ROW VERTICAL RECEPTACLE</u>	16 of 18
DOCUMENT NUMBER:	CREATED / REVISED BY:	CHECKED BY:	APPROVED BY:
PS-79107	SKANG 2011/06/03	ATSEE 2011/06/21	MLONG 2011/06/21



PRODUCT SPECIFICATION

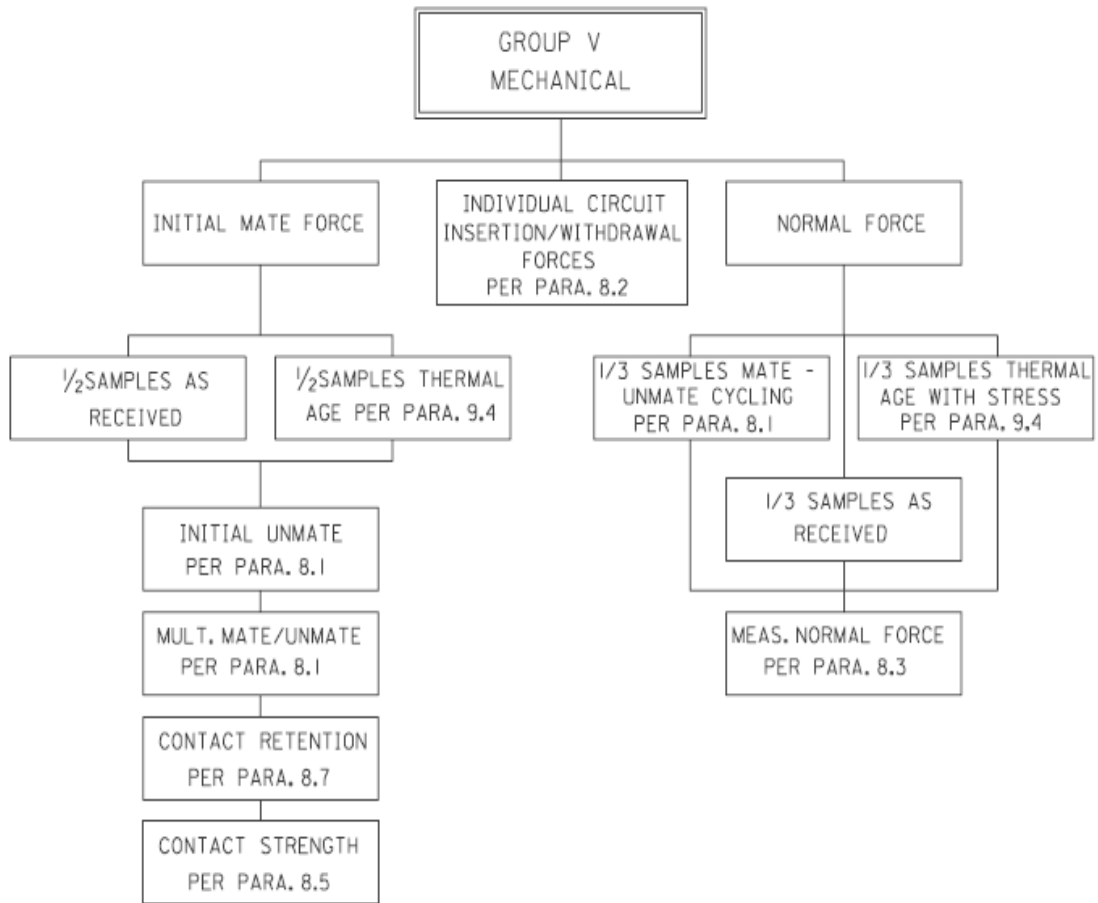

FIGURE 14

6/21/2011RE	ECR/ECN INFORMATION:	TITLE:	SHEET No.
B2	EC No: S2011-1026	<u>2MM DUAL ROW VERTICAL RECEPTACLE</u>	17 of 18
	DATE: 2011 / 06 / 03		
DOCUMENT NUMBER:	CREATED / REVISED BY:	CHECKED BY:	APPROVED BY:
PS-79107	SKANG 2011/06/03	ATSEE 2011/06/21	MLONG 2011/06/21



PRODUCT SPECIFICATION

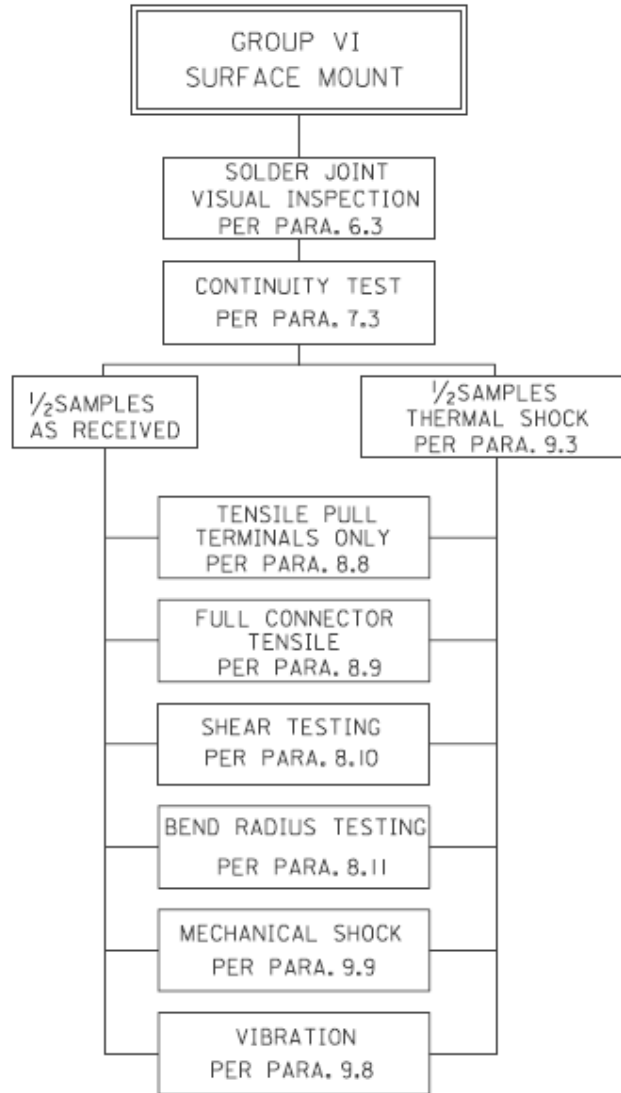

FIGURE I5

6/21/2011RE	ECR/ECN INFORMATION:	TITLE:	SHEET No.
B2	EC No: S2011-1026 DATE: 2011 / 06 / 03	<u>2MM DUAL ROW VERTICAL RECEPTACLE</u>	18 of 18
DOCUMENT NUMBER:	CREATED / REVISED BY:	CHECKED BY:	APPROVED BY:
PS-79107	SKANG 2011/06/03	ATSEE 2011/06/21	MLONG 2011/06/21