

# PROCENTEC



## ProfiHub B4F02+R

User Manual

**Copyright © 2019 PROCENTEC**

All rights reserved. No part of this publication may be reproduced, stored in a retrieval system, or transmitted, in any form or by any means, electronic, mechanical, photocopying, recording or otherwise, without the prior written permission of the publisher.

**Safety Guidelines**

This manual contains notices which you should observe to ensure your own personal safety, as well as to protect the product and connected equipment. These notices are highlighted in the manual by a warning sign and are marked as follows according to the level of danger:



Draws your attention to important information on handling the product, a particular part of the documentation or the correct functioning of the product.

**Warning**

This device and its components may only be used for the applications described in this manual and only in connection with devices or components that comply with PROFIBUS and an RS 485 interface. This product can only function correctly and safely if it is transported, stored, set up, installed, operated and maintained as recommended.

**Qualified Technicians**

Only qualified technicians should be allowed to install and work with this equipment. Qualified technicians are defined as persons who are authorized to commission, to ground, to tag circuits and systems in accordance with established safety practices and standards. It is recommended that the technicians carry a Certified PROFIBUS Installer or Certified PROFIBUS Engineer certificate.

**Disclaimer of Liability**

We have checked the contents of this manual as much as possible. Since deviations cannot be precluded entirely, we cannot guarantee full agreement. However, the content in this manual is reviewed regularly and any necessary corrections included in subsequent editions. Suggestions for improvement are welcomed.

# Important information

## **Purpose of the Manual**

This manual explains how to put the ProfiHub B4FO2+R into operation.

## **Recycling and Disposal**

The parts of the ProfiHub can be recycled. For further information about environment-friendly recycling and the procedure for disposing of your old equipment, please contact:

PROCEN TEC  
Klopperman 16  
2292 JD WATERINGEN  
The Netherlands

Tel.: +31-(0)174-671800  
Fax: +31-(0)174-671801  
Email: [info@procentec.com](mailto:info@procentec.com)

## **Document Updates**

You can obtain constantly updated information on PROCEN TEC products on the Internet at [www.procentec.com](http://www.procentec.com). You can also contact PROCEN TEC Customer Support:

- By phone at +31-(0)174-671800
- By fax at +31-(0)174-671801
- By email at [support@procentec.com](mailto:support@procentec.com)

# Contents

Important information .....	2
<b>1. Product description .....</b>	<b>5</b>
1.1 Introduction .....	5
1.2 Product features.....	6
1.3 Application areas.....	7
1.4 Additional benefits.....	7
1.5 Channel Structure .....	9
1.6 Grounding System .....	9
1.7 Cable lengths for PROFIBUS DP.....	10
1.8 Cable types for PROFIBUS DP.....	10
1.9 Cable lengths for fiber optic.....	11
1.10 Cable types for fiber optic.....	11
1.11 Status LEDs .....	12
1.12 The red Error LED .....	12
<b>2. Installation Instructions ProfiHub B4FO2+R.....</b>	<b>13</b>
2.1 Location.....	13
2.2 Position.....	13
2.3 Mounting.....	13
2.4 Power Supply.....	14
2.5 Grounding of the power .....	15
2.6 Alarm contact .....	15
2.7 Fiber optic backbone.....	16
2.8 Calculating the delay time.....	17
2.9 Spur Segments .....	17
2.10 Termination.....	18
2.11 Baudrate switch .....	19
2.11.1 B4FO2 (all serial numbers starting with 18 or lower) .....	19
2.11.2 B4FO2+R (All serial numbers starting with 19 or higher).....	20
2.12 Robust Repeating mode.....	20
2.13 Channel Redundancy.....	20
<b>3. Diagnostics Device.....</b>	<b>21</b>
3.1 Setting up the Diagnostics Device .....	24
3.1.1 Enabling the Diagnostics Device.....	24
3.1.2 Changing the default PROFIBUS address .....	24
3.1.3 GSD file.....	25
3.2 Configuring the Diagnostic Device .....	25

3.2.1	Info data (mandatory module).....	25
3.2.2	Alarm Confirmation.....	25
3.2.3	Redundant Status.....	25
3.2.4	Baudrate Status.....	26
3.2.5	Relay Status.....	26
3.2.6	Power Status.....	26
3.2.7	Termination Status.....	27
3.2.8	Channel Status.....	27
3.2.9	Livelist Status.....	27
3.2.10	Statistics (Short Format, Long Format).....	28
3.3	Parameterizing the Diagnostic Device.....	29
3.3.1	Diagnostics.....	29
3.3.2	Statistics.....	30
3.3.3	Extended Diagnostics on Events change.....	31
3.3.4	Extended Diagnostics on Statistics change.....	33
3.3.5	Alarm Relay on Events change.....	33
3.3.6	Alarm relay on Statistics change.....	34
3.3.7	Changing the Diagnostics duration/timeout.....	34
3.3.8	Changing the Device Lost timeout.....	35
3.3.9	Changing the data format.....	35
3.4	ProfiTrace plugin for the Diagnostic Device.....	36
3.4.1	Installing the Plugin.....	36
3.4.2	Using the Plugin.....	36
<b>4.</b>	<b>Technical Data ProfiHub B4FO2+R.....</b>	<b>38</b>
<b>5.</b>	<b>Sales offices and distributors.....</b>	<b>44</b>
<b>6.</b>	<b>Order codes.....</b>	<b>49</b>
<b>7.</b>	<b>Certificates.....</b>	<b>50</b>
<b>8.</b>	<b>Glossary.....</b>	<b>53</b>
<b>9.</b>	<b>About PROCENTEC.....</b>	<b>56</b>
<b>10.</b>	<b>Revision history.....</b>	<b>57</b>
<b>11.</b>	<b>Notes.....</b>	<b>58</b>

# 1. Product description

## 1.1 Introduction

**ProfiHub B4FO2+R is an advanced, flexible and robust network component for PROFIBUS DP installations, to create fiber optic backbone structures and long multi-device star/tree segments.**

PROFIBUS DP is a high speed communication bus that must comply with strict rules concerning spur lines, because of possible reflections that could lead to communication disturbances. If spur lines or star segments are required, costly investments in repeaters have to be done. When redundancy is enabled, the ProfiHub B4FO2+R is transformed to a low cost extremely reliable redundant repeater solution.

The innovative ProfiHub B4FO2+R is the perfect component for such applications. It is an economic solution to realise reliable spur lines in high speed DP networks. They have the functionality of 4 galvanic isolated transparent repeaters and an Optical Link Module (OLM) in one device. This allows network structures with extended spur lines that individually can handle a maximum of 31 devices and a length equal to the main bus. The ProfiHub B4FO2+R refreshes a received message on one Channel and transfers it to all the other Channels (chicken foot topology).

Because the ProfiHub B4FO2+R creates isolated segments, the devices can now be removed and added during operation. Also most electrical bus problems and EMC disturbances in a spur do not spread to the other segments. The intelligent logic and isolation circuits of the ProfiHubs do not change the bit width. This means the ProfiHubs do not have limitations in serial placement. The logic also detects the transmission speed automatically.

To assist the installation work, termination is integrated and can be switched on/off. The grounding concept is also selectable: direct or capacitive grounding. The ProfiHubs are powered by a 12 to 24 DC Voltage. For troubleshooting, maintenance and commissioning the ProfiHubs are equipped with LEDs on the outside, which indicate the status of each Channel (Data and Error).

If bus redundancy is enabled, 2 segments will form a redundant pair which is completely compatible with the ABB RLM01. An alarm contact is linked to events based on the status of the power supply and the bus redundancy status.



Fig. 1 – ProfiHub B4FO2+R

## 1.2 Product features

- 4 Galvanic isolated outgoing channels (repeater segments).
- Advanced Diagnostic capabilities
- 2 Fiber Optic channels.
- Transparent for all PROFIBUS DP protocols.
- DP - RS 485 specifications for each channel.
- Cable redundancy for copper channel 3 and 4
- 9.6 Kbps to 12 Mbps.
- 31 devices per channel.
- 3000 m cable length for FO channel 1 and 2
- 1200 m spur line length for copper channel 1 to 4 (depending on transmission speed).
- Redundant power supply
- No limit in serial placement or cascading of ProfiHubs.
- Alarm contact, with manual reset button.
- No address required (except for the B4FO2+R Diagnostics option)
- Integrated termination facilities (switches).
- Configurable grounding system (direct or capacitive).
- IP 20 classification
- Increased temperature range

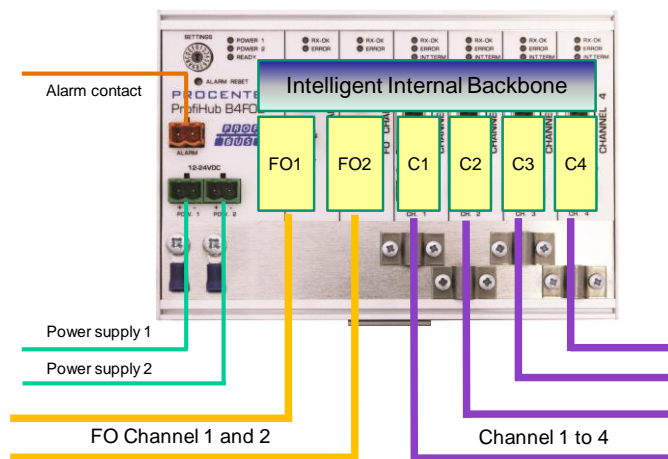

Fig. 2 - ProfiHub connections

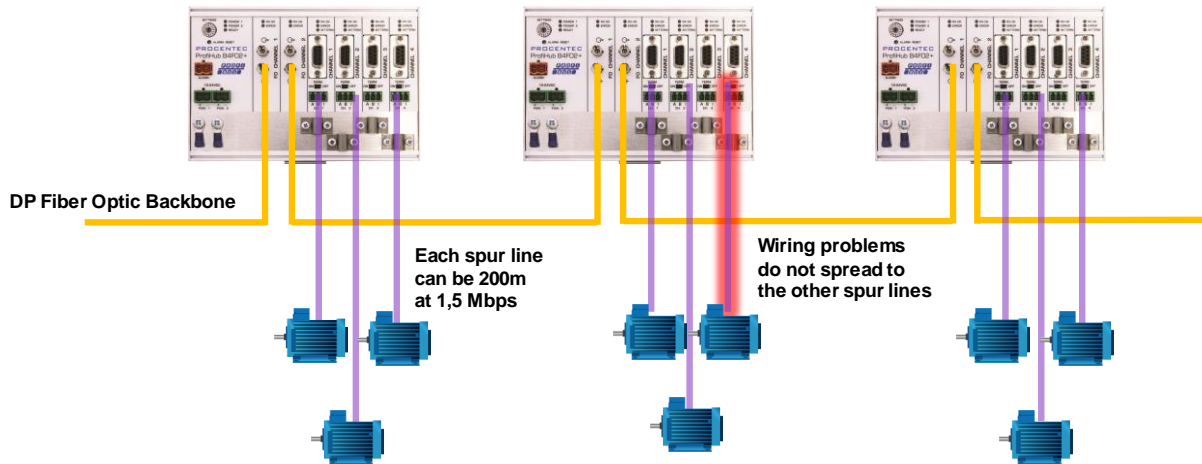

Fig. 3 - Long spur lines to instruments and the possibility to remove/insert them during operation. Short circuit protection on each spur line is automatically provided

### 1.3 Application areas

- Create Fiber Optic backbones
- Dynamic spur lines to actuators, flow meters and pH analyzers.
- Removable drives and motors.
- Pull/Plug motor control centers (drawers).
- Roof mounted devices in tank farms.
- Barrier for non-galvanic isolated equipment.
- Networks with requirement for High Availability/uptime
- Large star/tree structured networks.

### 1.4 Additional benefits

- Hot slave insertion and removal during operation.
- Create a redundant path to other Hubs or ComBricks
- Short circuit protection on each Channel.
- Option to create a redundant path to other supporting Hubs or ComBricks
- Compact and robust construction.
- Status and error display (per Channel).
- Suitable for all DP cables.
- Conveniently arranged networks.
- Easy extendable installations.
- On-board DB9 female connector on each channel for maintenance activities.
- Cost Savings



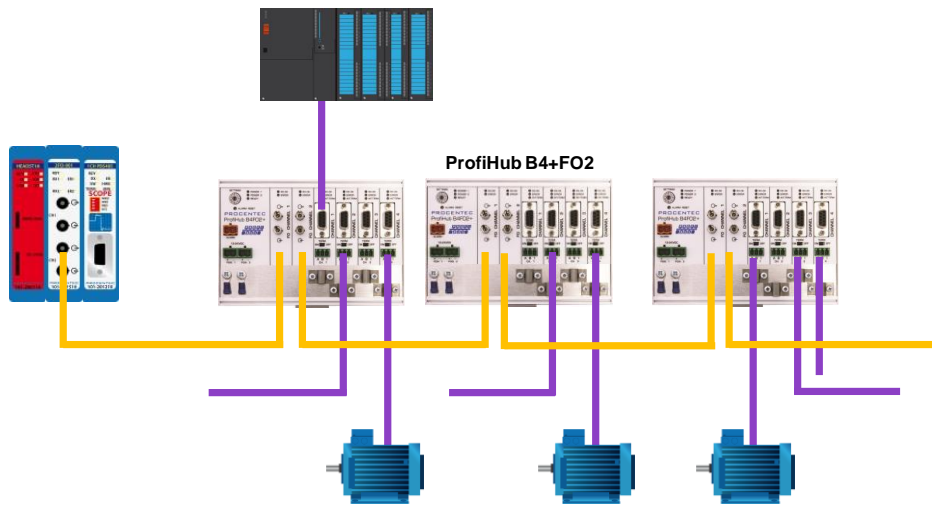

Fig. 4 - Creating a fiber optic backbone increases network reliability and network overview. It is also possible to mix Profihubs with ComBricks

## 1.5 Channel Structure

Each copper channel is electrically isolated and internally connected to the transparent intelligent backbone. The termination is switchable and powered by the ProfiHub. The shielding of the PROFIBUS cable can be directly grounded or indirectly grounded (see the next paragraph).

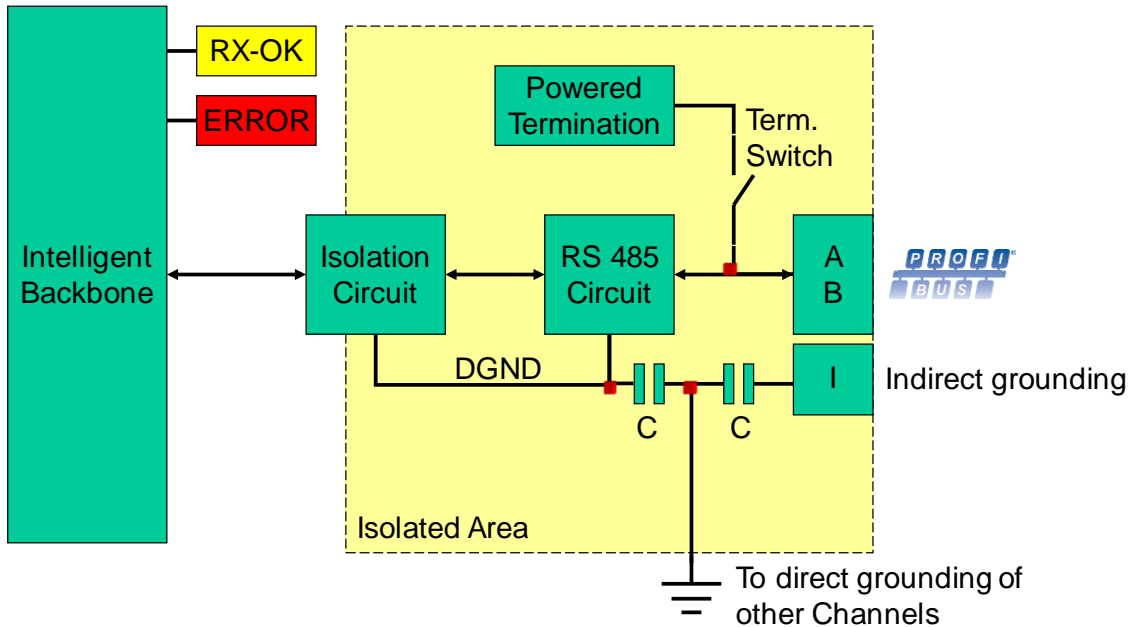

Fig. 5 - Channel structure

## 1.6 Grounding System

The ProfiHub B4FO2+R can be grounded by 3 methods:

- 1) Direct grounding on the Ground Rail
- 2) Indirect grounding (through a capacitor)
- 3) Combination of direct and indirect.

The power supply must be grounded directly on the Ground Rail. The shielding of the PROFIBUS cables can be directly or indirectly grounded. If you do not want to ground all or some cables to the common ground, i.e. compensating current, the cable shielding must be connected to pin 'I' which stands for Indirect grounding. A capacitor with a parallel high value resistor will separate the 2 potentials (Fig. 5), ensuring protection of the signal against non-DC disturbances.

If by accident on 1 channel the Direct Grounding is connected with the Indirect Grounding, the connection to the Direct Grounding bypasses the capacitor in the Indirect Ground connection. The current on the shield will flow to Direct Ground.

## 1.7 Cable lengths for PROFIBUS DP

The cables on Channels 1 to 4 must comply with the PROFIBUS DP cable specifications for RS 485 (see Fig. 6).

Baudrate (kbit/s)	9.6	19.2	45.45	93.75	187.5	500	1500	3000	6000	12000
Segment length (m)	1200	1200	1200	1200	1000	400	200	100	100	100
Segment length (feet)	3940	3940	3940	3940	3280	1310	656	328	328	328

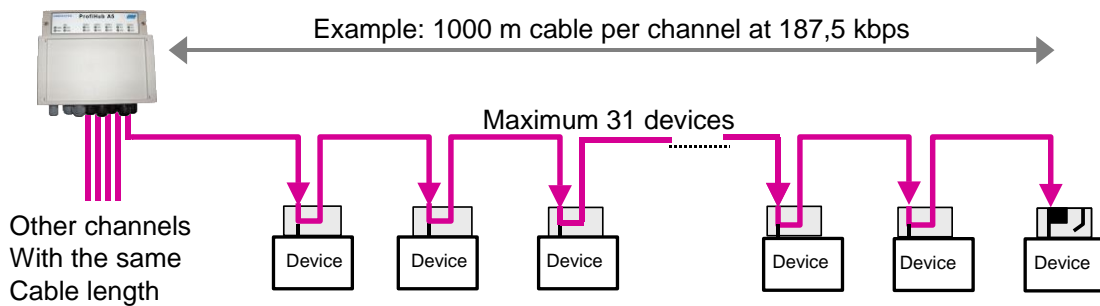

Fig. 6 - Cable lengths for PROFIBUS DP

## 1.8 Cable types for PROFIBUS DP

The cable type must comply with the PROFIBUS DP cable specifications for RS 485 (Fig. 7).

Parameter	Value
Wires	2 (twisted)
Impedance	135 .. 165 Ohm at 3 to 20 MHz
Capacity	< 30 pF/m
Loop resistance	< 110 Ohm/km
Wire diameter	> 0.64 mm
Wire area	> 0.32 mm <sup>2</sup>

Fig. 7 - PROFIBUS DP cable specifications

The ProfiHub B4FO2+R can handle cables based on multiple protection sheaths with an overall cable diameter between 6 to 12 mm (Fig. 8).

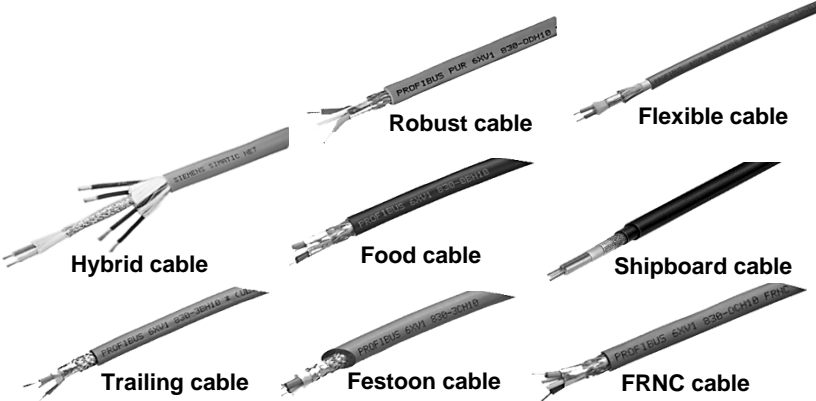

Fig. 8 - Cables with different protection sheaths

### 1.9 Cable lengths for fiber optic

The maximum cable length for fiber optic cables is 3 kilometers if G62.5 / 125 or G50/125 cable is used. If PCF/HCS cable is used, the maximum is 200 meters.



















### 1.10 Cable types for fiber optic

The following cable types can be used with the ProfiHub B4FO2+R:

G62.5/ 125	G50 / 125	PCF/HCS
ISO / IEC 11801 (OM1)	ISO / IEC 11801 (OM2 or better)	200/230 μm (not further specified)
IEC 60793-2-10 type A1b	IEC 60793-2-10 type A1a	
TIA / EIA 492AAAA	TIA / EIA 492AAAB-A	
ITU-651.1	ITU-651.1	

## 1.11 Status LEDs

The Status LEDs on the ProfiHub are very useful for diagnostics.

	OFF	Blinking	ON
<b>POWER 1 / 2</b>	 Power is not switched on or an internal error	 Power supply not stable, redundant power supply interrupted or an internal failure	 Power supply OK
<b>READY</b>	 Power is not switched on or an internal error	 Trying to detect the transmission speed, but has not locked it yet	 The transmission speed has been detected
<b>FO RX-OK</b>	 No communication detected on this channel	 1 or more devices communicating on this channel	 Internal error
<b>FO ERROR</b>	 No problem has been detected	 Problem in the cabling has been detected.	 Problem in the cabling has been detected
<b>Channel RX-OK</b>	 There is no communication detected on this channel	 1 or more devices communicating on this channel	 Internal error
<b>Channel ERROR</b>	 No problem has been detected	 Problem in the cabling has been detected	 Problem in the cabling has been detected
<b>INT. TERM</b>	Termination for this channel is OFF	 Internal error	Termination for this channel is ON

## 1.12 The red Error LED

The red error LEDs will blink shortly if a corrupt message enters the ProfiHub. More specifically, this can be a Parity error (the parity checksum of the byte is incorrect) or a Framing error (the FCS byte is different than the real message). It is necessary to investigate further with an oscilloscope to find out what the problem is. This can easily be done with ProfiTrace.

Another reason for the red error LED is a problem in the redundant cabling (if the ProfiHub is set to redundant). If the redundant line is fixed, press the 'Alarm Reset' button.

It can also be that the baudrate is not locked (no PROFIBUS master on the bus) or the baudrate was set manually and incorrectly with the rotary switch.

## 2. Installation Instructions ProfiHub B4FO2+R

### 2.1 Location

The ProfiHub B4FO2+R can be installed everywhere in a non-hazardous area that complies with IP 20 (DIN 40 050) and the specified temperature range of -25 to +70° Celsius or -13 to +158° Fahrenheit.

### 2.2 Position

The ProfiHub B4FO2+R can be installed in every position, but it is recommended to install it with the cables pointing down. In this position it is also easier to read the status LEDs.

### 2.3 Mounting

The ProfiHub B4FO2+R can be mounted on 35 mm DIN-rail with a minimum width of 167 mm. Mounting brackets are available for mounting the B4FO2+R directly on a wall.

The supplied rubber studs need to be placed on the back of the housing of the ProfiHub B4FO2+R for extra fixation. This is to prevent the product to potentially slide off the DIN-rail. See Fig. 9 for an example.



Fig. 9 - Rubber studs on backside of housing

## 2.4 Power Supply

The two 2-pin screw type power connectors are located on the left of the ProfiHub B4FO2+R (Fig. 10).

1 = + (left)

2 = - (right)

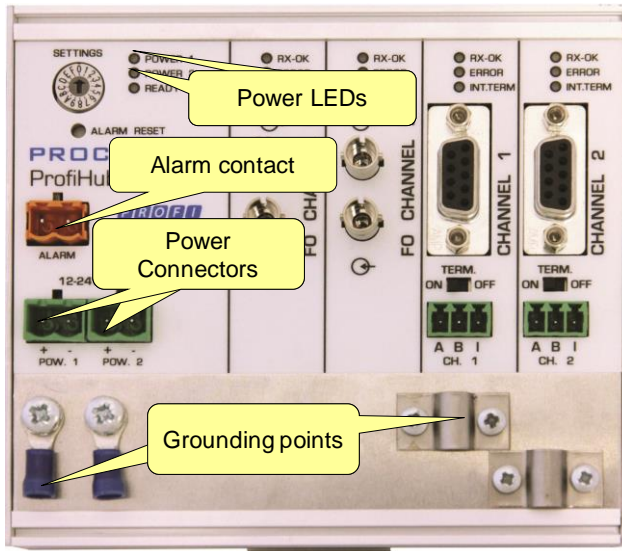

Fig. 10 - Power connectors and LEDs

Both power connectors are linked 1-on-1 to the internal power supply of the B4FO2+R. If one power supply fails, the other takes over without delay time. When redundancy is not required, it is sufficient to use one power connector. Please note that when using only one power supply, a voltage of max. 0.25 V will exist on the other unconnected power connector, as shown in Fig. 11.

If only one power supply is used, the alarm contact is closed. If two power sources are connected, the contact is open. As soon as one of the power supplies fails, the contact will close and the Power Indicator LED will blink.

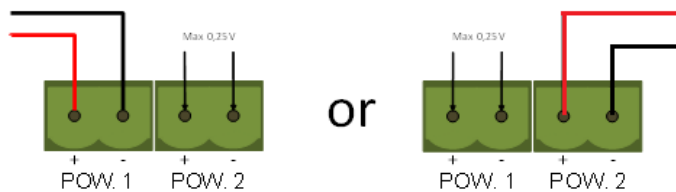

Fig. 11 - Maximum voltage on unconnected Power Connector

The power supply must comply with the following specifications:

- Limited Power Source (LPS) or NEC Class 2 or CEC Class 2
- Voltage: **12 - 24 VDC**
- Current: **min 300 mA**
- Wire diameter: **< 2.5 mm<sup>2</sup>**

### Procedure

To connect the 24V supply to the 2-pin screw-type terminal, proceed as follows:

- Strip the insulation from the cable or the conductors for the 24V power supply.
- Add cable crimp terminals/wire ferrules to the conductors.
- Secure the crimp terminals in the screw-type terminal.

To connect the power supply, you need a 3 mm screwdriver.

#### Testing:

If the power is switched on it can be diagnosed by the following indicators:

- LEDs should be blinking in a circular animation for a short time.
- The POWER LED of the respective power connector (1, 2 or both) is ON.
- The READY LED is ON or Blinking, depending on baud rate lock.

## 2.5 Grounding of the power



It is recommended to use a power supply with a ground lead (3-wire). Connect the ground lead of the power lead to the Ground Rail of the ProfiHub B4FO2+R. Connect the Ground Rail to the common ground with a separate ground lead. See Fig. 12 for an example.

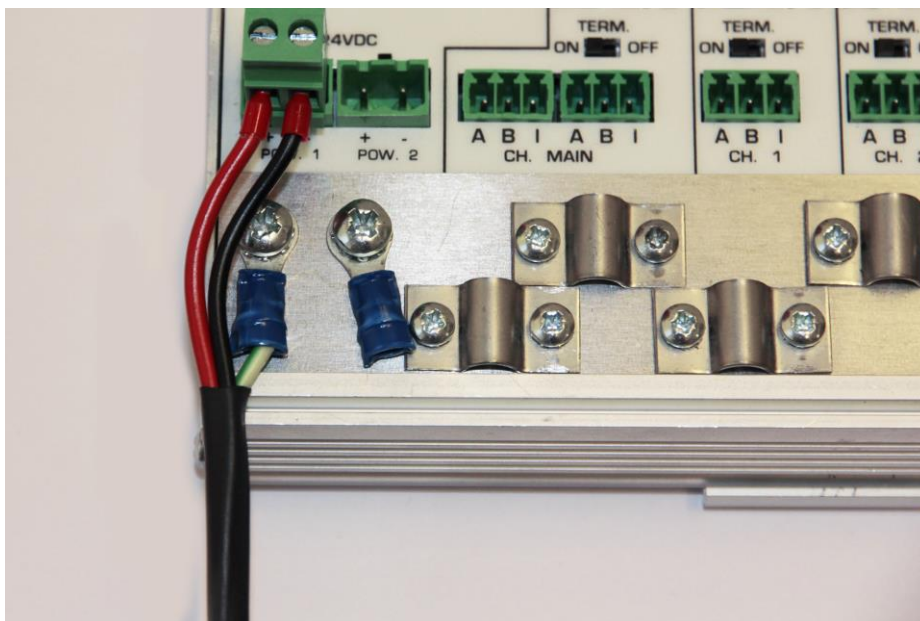

Fig. 12 - Connection to Ground Rail

## 2.6 Alarm contact

The ProfiHub B4FO2+R features a potential-free relay contact. This alarm contact can be used to monitor the power supplies. Example applications are: Connect a LED tower, alarm buzzer, SMS server or use it as a digital signal for the PLC. The relay can also be used for alarming in case of retries, illegals, or other events. For more information refer to Chapter 3.

If only one power supply is used, the alarm contact is closed after 60 seconds after start-up. If two power sources are connected, the contact is open. When one of the power supplies fails for 3 seconds or more, the contact will close and the Power Indicator LED will blink. If you are using only one power source and wish to use the Relay contact, simply connect Power 1 to Power 2.

In the case of an interrupted power supply you can reset the contact by pressing the 'Reset' button. The contact will open and the LEDs will stop blinking.

The Alarm contact is also switched when the ProfiHub is in Redundant mode and one of the redundant paths fails.



The maximum power to be connected to the alarm contact is 24 VDC. The maximum current consumption is 500 mA.

## 2.7 Fiber optic backbone

Use the FO channels to create a fiber optic backbone to other ProfiHubs with FO channels or to ComBricks. Connect the DP copper cable from the master or DCS to one of the two copper channels (Fig. 13).

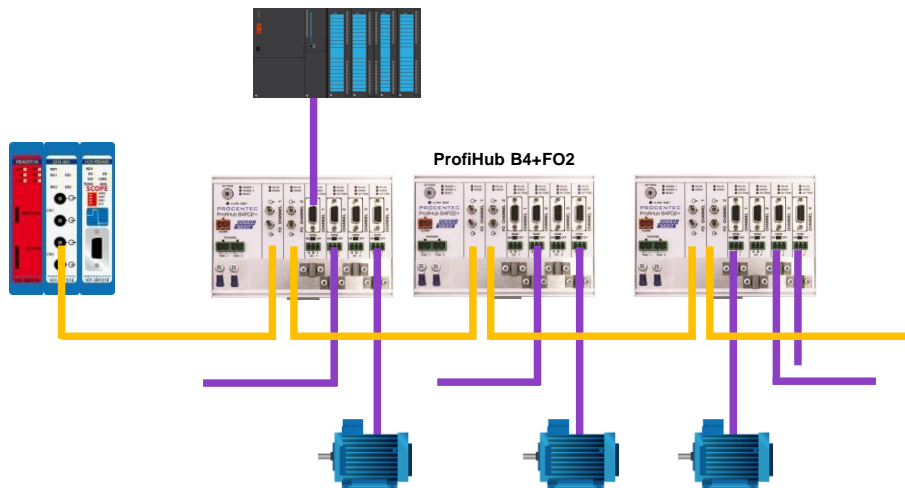

Fig. 13 - Fiber optic backbone

### Pin layout of the screw terminals:

Pin "A": Green wire

Pin "B": Red wire

Pin "I": Indirect cable shielding

Note: Connecting the Indirect cable shielding is not required when the ground clips are used.

### Testing

If a channel recognizes valid PROFIBUS messages from one or more connected devices, the RXOK LED of the corresponding channel should be blinking.

## 2.8 Calculating the delay time

Fiber optic applications require a delay time calculation to adjust the MaxTSDR and Slottime (Tslot) busparameters in the configuration of the master(s). The B2FO2+R complies with the following formulas:

$$T_{\text{SLOT}} \geq \text{MaxTSDR} + ((\text{FO}_{\text{length}} \times \text{FO}_{\text{delay}}) + (\text{N}_{\text{FO-modules}} \times \text{N}_{\text{delay}})) \times 2$$

- $\text{FO}_{\text{length}}$  = Total length of fiber optic cable in km
- $\text{FO}_{\text{delay}}$  = Delay of fiber optic cable per km in bit times (see table)
- $\text{N}_{\text{FO-modules}}$  = Number of fiber optic modules in cascade
- $\text{N}_{\text{delay}}$  = Delay of one fiber optic module (see table)

The delay time is multiplied by 2 for a request and response message

Baudrate	MaxTSDR [Tbit]	FO <sub>delay</sub> [Tbit/km]	N <sub>delay</sub> Normal mode [Tbit]	N <sub>delay</sub> Robust and Red. Mode [Tbit]
12 Mbps	800	60	7	16
6 Mbps	450	30	5	16
3 Mbps	250	15	4.5	15
1.5 Mbps	150	7.5	4	15
500 kbps	100	2.5	3	14
187.5 kbps	60	0.94	3	14
93.75 kbps	60	0.47	3	14
45.45 kbps	400	0.23	3	14
19.2 kbps	60	0.1	3	14
9.6 kbps	60	0.05	3	14

Note:  $\text{FO}_{\text{delay}} = (\text{FO}_{\text{cable\_length}} / \text{FO}_{\text{cablelatency}}) / \text{Bit}_{\text{time}}$

example  $\text{FO}_{\text{delay}}$ , 1km, 1.5Mbps:  $(1000 \text{ m} / 200 \text{ } \mu\text{sec/m}) / 0.666 \text{ } \mu\text{sec} = 7.5 \text{ Tbit/km}$

### Example 1: 1.5 Mbps, 3 km FO cable, 2 units Normal mode

$$T_{\text{SLOT}} \geq \text{MaxTSDR} + ((\text{FO}_{\text{length}} \times \text{FO}_{\text{delay}}) + (\text{N}_{\text{FO-modules}} \times \text{N}_{\text{delay}})) \times 2$$

$$T_{\text{SLOT}} \geq 150 + ((3 \times 7.5) + (2 \times 4)) \times 2 \geq \mathbf{211 \text{ bit times}}$$

### Example 2: 1.5 Mbps, 3 km FO cable, 2 units Robust mode

$$T_{\text{SLOT}} \geq \text{MaxTSDR} + ((\text{FO}_{\text{length}} \times \text{FO}_{\text{delay}}) + (\text{N}_{\text{FO-modules}} \times \text{N}_{\text{delay}})) \times 2$$

$$T_{\text{SLOT}} \geq 150 + ((3 \times 7.5) + (2 \times 15)) \times 2 \geq \mathbf{255 \text{ bit times}}$$

### Example 3: 6 Mbps, 10 km FO cable (total line length), 10 units in cascade

$$T_{\text{SLOT}} \geq \text{MaxTSDR} + ((\text{FO}_{\text{length}} \times \text{FO}_{\text{delay}}) + (\text{N}_{\text{FO-modules}} \times \text{N}_{\text{delay}})) \times 2$$

$$T_{\text{SLOT}} \geq 450 + ((10 \times 30) + (10 \times 5)) \times 2 \geq \mathbf{800 \text{ bit times}}$$

## 2.9 Spur Segments

Connect the spur segments to the connectors of Channel 1 and 2 (**Error! Reference source not found.**). The second method is to place a PROFIBUS standardized plug on the DB9 connector of the specific Channel.

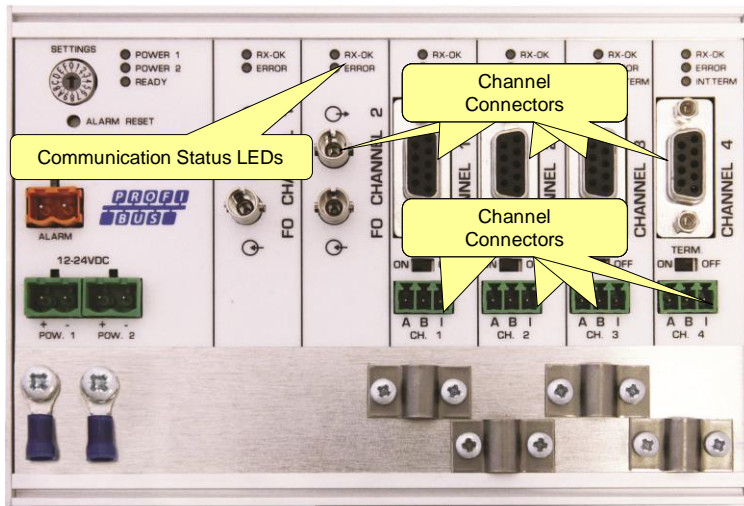

Fig. 14 - PROFIBUS DP spur connectors

**Pin layout of the screw terminals:**

Pin "A": Green wire

Pin "B": Red wire

Pin "I": Indirect cable shielding, for reducing EMC and noise in demanding areas

Note: Connecting the Indirect cable shielding is not required when the ground clips are used.

**Testing**

If a Channel recognizes valid PROFIBUS messages from one or more connected devices, the RXOK LED of the Channel should be blinking.

**2.10 Termination**

The termination of the Channels have been set to ON by default, because it is assumed that the new segment is started at the ProfiHub (**Error! Reference source not found.**).

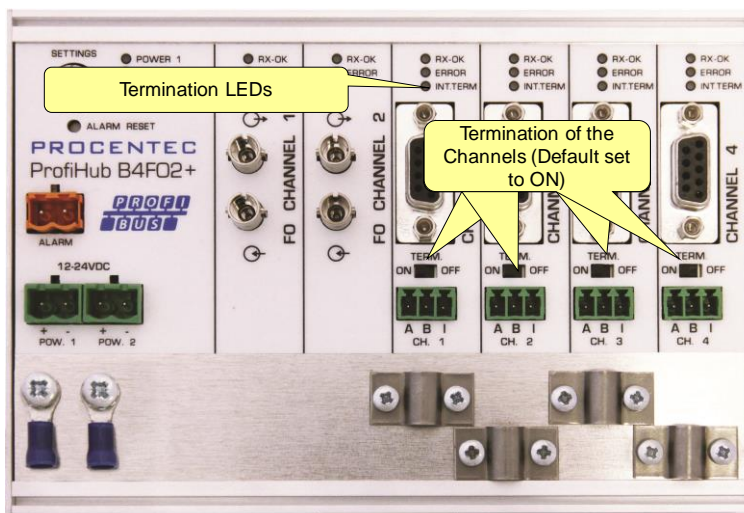

Fig. 15 - Termination switches

The termination LED of the corresponding Channel is activated when the termination switch is set to ON.



When the DB9 connector is used and the cable starts at the ProfiHub, it is recommended to use the termination on the DB9 plug and NOT the ProfiHub. This way, the connector can be removed while maintaining termination on the bus.

## 2.11 Baudrate switch

### 2.11.1 B4FO2 (all serial numbers starting with 18 or lower)

If the serial number of your ProfiHub starts with 18 or lower, follow this paragraph for the dipswitch settings.

The ProfiHub B4FO2 recognizes the transmission speed by default. If it is required that the ProfiHub B4FO2 is locked to a certain transmission speed, the baudrate switch should be set to the required value (Fig. 16).

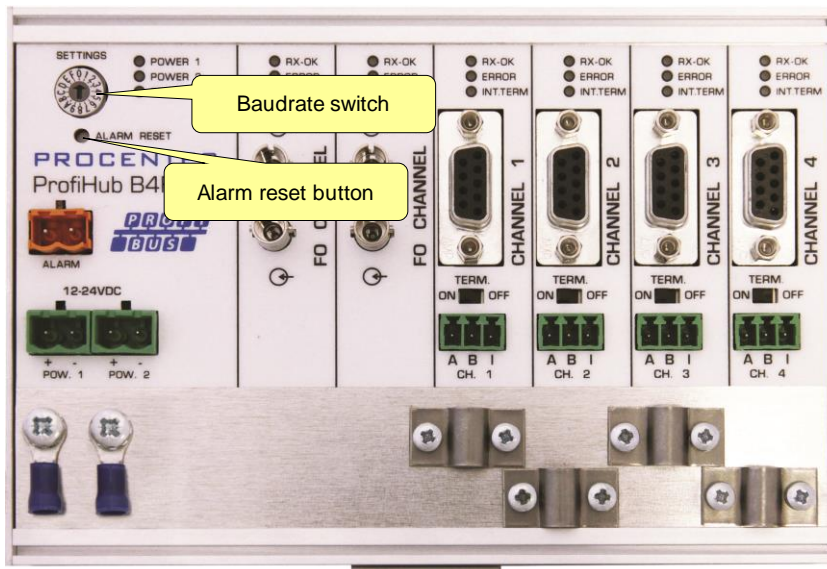

Fig. 16 - Baudrate speed switch

To set the rotary switch, use a 3 mm screwdriver.

#### Switch values:

- 0 = Normal repeating, Auto detect (default)
- 1 = 9.6 kbps
- 2 = 19.2 kbps
- 3 = 45.45 kbps
- 4 = 93.75 kbps
- 5 = 187.5 kbps
- 6 = 500 kbps
- 7 = 1500 kbps
- 8 = 3000 kbps
- 9 = 6000 kbps
- A = 12000 kbps
- B = Robust repeating, Auto baudrate detect
- C = Robust repeating, redundancy on copper channel 3 and 4
- D-F = Normal repeating, Auto detect

Please note that the position of the rotary switch is only sampled during start-up. Changing the position of the switch will not have effect during operation.

The auto baudrate detect feature will search for the correct baud rate within 10 seconds of receiving the first telegram. This baud rate lock will be lost after 50 seconds of incorrect or no message reception.

## 2.11.2 B4FO2+R (All serial numbers starting with 19 or higher)

If the serial number of your ProfiHub starts with 19 or higher, follow this paragraph for the dipswitch settings.

To set the rotary switch, use a 3 mm screwdriver.

The rotary switch for the B4FO2+R has the following options:

Switch values:

Rotary switch	Auto detect	Robust repeating	Redundancy	Diagnostic slave
0	•			
1	•	•		
2	•	•	•	
3	•			•
4	•	•		•
5	•	•	•	•
6-F	•			

A change of the rotary switch setting is immediately active without restarting the device.

The auto baudrate detect feature will search for the correct baud rate within 10 seconds of receiving the first telegram. This baud rate lock will be lost after 50 seconds of incorrect or no message reception.

In robust repeating mode, only messages starting with a valid PROFIBUS start delimiter are repeated (SD1, SD2, SD3, SD4 and Short Acknowledge). In Normal mode, every bit is transferred immediately onto the other channels.

## 2.12 Robust Repeating mode

The B4FO2+R has two repeating modes: normal ((rotary switch setting 0 and 3)) and Robust Repeating (rotary switch setting 1, 2, 4 or 5). In normal mode the bits are transferred directly on the other channel with a minimal delay (see Delay Times in the Technical Data chapter). In Robust mode, the first byte is checked to verify if the following bits are a real PROFIBUS message. If the byte is illegal, the message will not be transferred to the other channel. This helps network stability in EMC sensitive environments.

### ATTENTION:

Using the ProfiHub B4FO2+R in Robust Repeating mode causes a delay in processing the telegrams. It is required to increase the default MinTSDR in the PLC busparameters slightly. Recommended is to increase the MinTSDR with a value according to the Delay Time table, column 'Robust Mode', described in the Technical Data chapter. Generally a MinTSDR of 25 is sufficient. If long fiber optic cables or many optical link modules (OLMs) are used, check paragraph **Error! Reference source not found.** for an example of the MinTSDR calculation.

## 2.13 Channel Redundancy

To use the Redundancy option of the B4FO2+R, set the rotary switch to 2 or 5. This enables the last two copper channels (3 and 4) to be one redundant path to another B4FO2+R, a B5+, to a redundant ComBricks, or to any other supporting product. See Fig. 17 for an example.

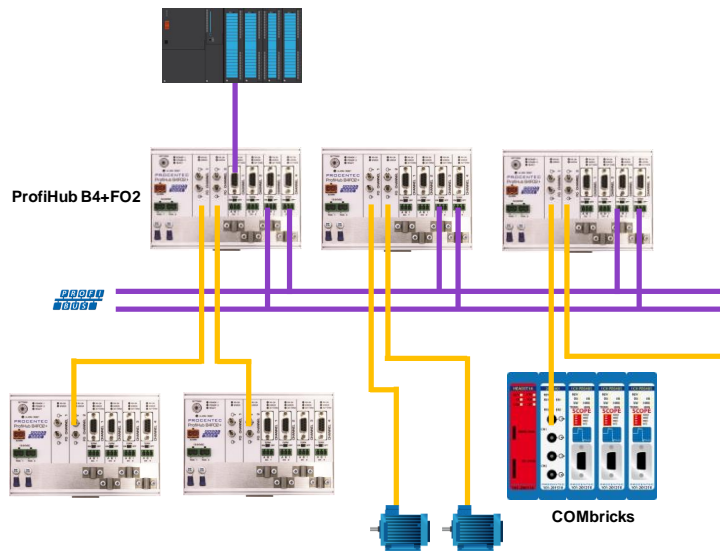

Fig. 17 - Redundant path between multiple ProfiHubs

The telegrams are transferred onto both redundant channels. The logic inside the ProfiHub determines which telegram is used to be transferred onto the other channels. A message received by a redundant channel is repeated on all other channels, except the other redundant channel. A message received by a normal channel is repeated on all other channels.

When one redundant cable breaks, the other cable ensures safe delivery of the telegram. In this event the built-in alarm contact will close. The red 'ERROR' LED will blink with an interval of 100ms. When the redundant path is fixed, press the 'ALARM RESET' pushbutton to reset the alarm.

#### ATTENTION:

Using the ProfiHub B4FO2+R in Redundancy mode causes a delay in processing the telegrams. It is required to increase the default MinTSDR in the PLC busparameters slightly. Recommended is to increase the MinTSDR with a value according to the Delay Time table, column 'Robust Mode', described in the Technical Data chapter. Generally a MinTSDR of 25 is sufficient. If long fiber optic cables or many optical link modules (OLMs) are used, check paragraph **Error! Reference source not found.** for an example of the MinTSDR calculation.

### 3. Diagnostics Device

The B4FO2+R comes with a built-in Diagnostics Device. The Diagnostics Device is a very versatile statistics/diagnostics logger. It can be used to keep track of the overall PROFIBUS network health and inform the PLC or DCS of any network failure such as repeats or illegals, missing ProfiHub termination, live list changes, or power supply problems. Audible or visible feedback is also possible by automatically switching the integrated alarm relay.

You can use a ComBricks to display the most important diagnostics of every channel. The information of this ProfiHub Diagnostics slave is displayed as follows:

**PROCENTEC ComBricks**

IP address: 192.168.13.237    MAC address: 9C:B2:06:00:1C:04    System uptime: 0 days, 23:54:50  
 Site:    Temperature: 42°C    System time: 4-Jan-2019 14:08:07  
 Company:    Country:

### ProfiHub diagnostic slave info

ProfiHub B4FO2+RD (Address: 24 (Lower-Left), Serial#: 102)    Clear selected device    Show overview

Diagnostic slave info	
Last update:	4-Jan-2019 14:07:56
ProfiHub type and serial number:	ProfiHub B4FO2+RD (Serial#: 102)
ProfiHub firmware version:	V2.0
ProfiHub diagnostic slave address:	24 (Lower-Left)
Connected to this ComBricks:	Network 1 (Module 1, Channel 1)
Redundancy status:	Redundancy not used
Power 1 connected:	Yes
Power 2 connected:	Yes
Alarm status:	Inactive <span>Reset alarm</span>

Internal Diag slave	FO Ch 1	FO Ch 2	Ch 1	Ch 2	Ch 3	Ch 4
24	1		60			
	2		61			
	20					
	21					
	22					
	23					
	40					
	41					
	42					

Fig. 18 - Information window of the Diagnostic slave

It displays the following information:

- Address and Tag-name of the Diagnostic slave
- Type and serial number of the Diagnostic slave
- Firmware version of the Diagnostic slave
- Connection to the Network, Module and Channel number of the ComBricks
- Redundancy status of the ProfiHub
- Power status of the ProfiHub
- Alarm status (of the relay)
- Termination status of all channels
- Illegal count for all channels
- A live list of all channels

For more information see the ComBricks manual, paragraph 'Diagnostic Slave info'.



The diagnostic information can also be read easily with ProfiTrace because the Diagnostic Device sends this data over PROFIBUS. This enables maintenance engineers to immediately identify the affected segment in case of cable problems or instrument failure. Having a Diagnostics Device in your network dramatically decreases downtime because problems can be solved much quicker; it tells you where to look. SCADA applications can make this even easier.

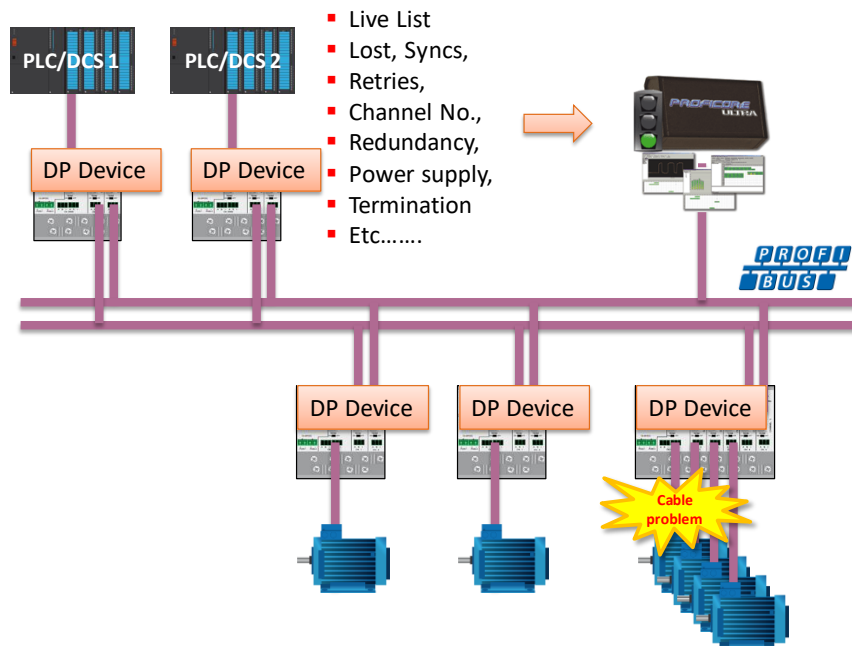

Fig. 19 – Cable problems or node loss can be identified by the ProfiHub channel, and send this information over PROFIBUS to the PLC. ProfiTrace can also read this.

The following statistics and events are continuously monitored:

Events:	Statistics:
<b>Alarm Relay opened/closed</b>	Losses
<b>Cable Redundancy change</b>	Syncs
<b>Baudrate change</b>	Repeats (total)
<b>Power input changed</b>	Repeats (max. changed in 1 cycle)
<b>Termination of Channel changed</b>	Illegals
<b>Communication on Channel stopped/started</b>	Internal Diagnostics
<b>Livelist changed (station removed or added)</b>	External Diagnostics
	Diagnostics while in Data Exchange

All of these events and statistics can be transferred in four different ways, so that the PLC/DCS or user can be warned that something is happening in the PROFIBUS network: a PROFIBUS input message, a diagnostic message, an external diagnostics message, or it can trigger the built-in alarm relay.



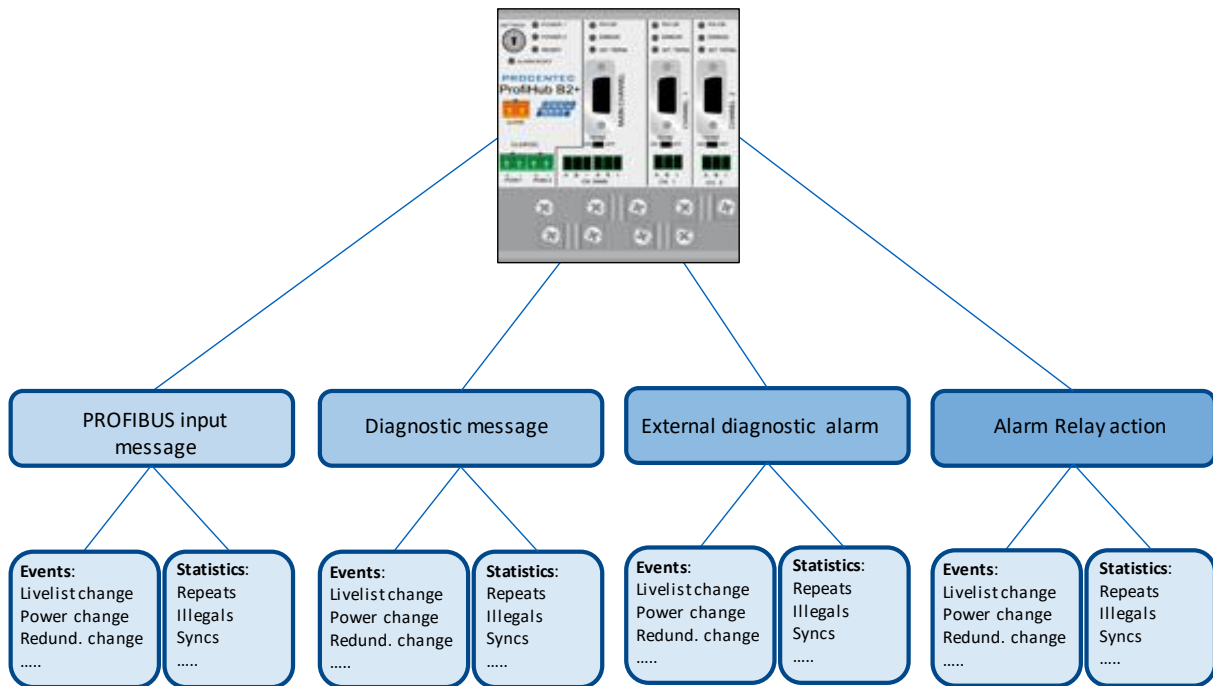

Fig. 20 - Ways of notifying the user in case of problems

### 3.1 Setting up the Diagnostics Device

#### 3.1.1 Enabling the Diagnostics Device

To enable the Diagnostics Device in the ProfiHub, set the rotary switch on the top left side to position 3, 4 or 5 (for a complete list of rotary switch settings, refer to the Technical Data chapter). Next, power-cycle the device by removing power and applying the power again. The rotary switch position is only read during start-up of the ProfiHub.

#### 3.1.2 Changing the default PROFIBUS address

By default the address of the Diagnostic Device is set to 126. To change the address, use a configuration tool which supports the 'Set Slave Address' command. Most configuration tools support this feature.

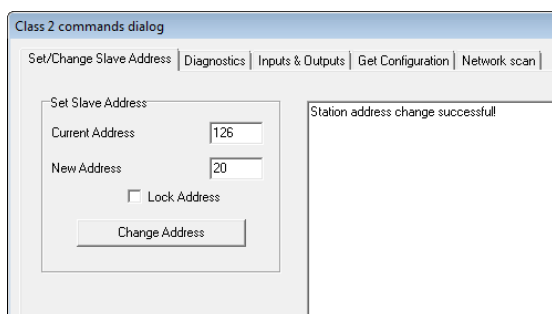

Fig. 21 - ProfiCaptain changes the address from 126 to 20

### 3.1.3 GSD file

Locate and download the appropriate GSD file for the Diagnostics Device on [www.procentec.com/downloads](http://www.procentec.com/downloads). The correct GSD file for the ProfiHub B4FO2+R is: **PROC6973.gsd**. The zip file also contains the corresponding .bmp (Bitmap) files. Import the GSD file into your configuration tool and insert the device in the PLC hardware configuration.

## 3.2 Configuring the Diagnostic Device

The Diagnostic Device has many configuration options. It can be configured modularly. This paragraph describes all the available options per module in list order.

### 3.2.1 Info data (mandatory module)

There is only one mandatory module, which is the first module in the list (“INFO DATA MANDATORY ON 1<sup>st</sup> SLOT”). It has 4 input bytes with the following meaning:

- Byte 1: Input Identifier byte (always 0xDE)
- Byte 2: Device type byte (0xF4 is ProfiHub B4FO2+R)
- Byte 3: Version byte: 0x01
- Byte 4: Data format byte (0x00 is Little Endian, 0x01 is Big Endian)

### 3.2.2 Alarm Confirmation

Input Identifier byte: 0x01

The Alarm Confirmation module has one Output, which can be used to reset the alarm. If the Alarm Relay has been triggered by any event, it can be reset by the PLC by sending 0x01 or higher to the output of this module.

### 3.2.3 Redundant Status

Input Identifier byte: 0x10

The next input byte is to indicate the status of the redundant path. It is divided in nibble 0..3 and 4..7.

Nibble 1 (0..3)	Meaning
1 dec	Redundancy not used
2 dec	Redundancy error left channel
3 dec	Redundancy error right channel
4 dec	Redundancy error both channels
5 dec	Redundancy OK
Nibble 2 (4..7)	
1 dec	Pending Alarm: Redundancy error left channel
2 dec	Pending Alarm: Redundancy error right channel
3 dec	Pending Alarm: Redundancy error both channels

Examples: 0x12 means Redundancy error on Left Channel, Pending alarm on Left Channel  
0x05 means Redundancy OK

### 3.2.4 Baudrate Status

Input Identifier byte: 0x11

The next input byte is to indicate the baudrate lock status.

Dec	Meaning
1	No baudrate detected
2	9.6 Kbit
3	19.2 Kbit
4	45.45 Kbit
5	93.75 Kbit
6	187.5 Kbit
7	500 Kbit
8	1.5 Mbit
9	3 Mbit
10	6 Mbit
11	12 Mbit

### 3.2.5 Relay Status

Input Identifier byte: 0x12

The next input byte is to indicate the alarm relay status.

Hex	Meaning
00	Relay is off
01	Relay is on

### 3.2.6 Power Status

Input Identifier byte: 0x13

The next input byte is to indicate the status of the power inputs.

Nibble 1 (bit 0..3)	Meaning
0	Power 1 is active
1	Power 2 is active
Nibble 2 (bit 4..7)	
4	Pending Alarm: Power 1 not active
5	Pending Alarm: Power 2 not active

Examples: 0x03: Power 1 and 2 are active  
0x21: Power 1 is active, pending alarm: Power 2 not active  
0x32: Power 2 is active, pending alarm: Power 1 and 2 not active (Relay should be reset in this case)

### 3.2.7 Termination Status

Input Identifier byte: 0x14

The next input byte is to indicate the status of the termination switches on the ProfiHub channels.

Bit	Meaning
0	0
1	0
2	Channel 1 termination ON
3	Channel 2 termination ON
4	Channel 3 termination ON
5	Channel 4 termination ON

Examples: 0x3C = All terminations are ON  
0x04 = Only Channel 1 termination is ON

### 3.2.8 Channel Status

Input Identifier byte: 0x15

The next input byte is to indicate the communication status of the individual channels.

Bit	Meaning
0	Communication on FO Channel 1
1	Communication on FO Channel 2
2	Communication on Channel 1
3	Communication on Channel 2
4	Communication on Channel 3
5	Communication on Channel 4

Examples: 0x06 = Communication on FO Channel 2 and Channel 1  
0x01 = Communication on FO Channel 1

### 3.2.9 Livelist Status

Input Identifier byte: 0x20

The next input byte is to indicate which Channel is selected to display the Livelist status.

Hex	Meaning
80	Livelist of FO Channel 1
81	Livelist of FO Channel 2
82	Livelist of Channel 1
83	Livelist of Channel 2
84	Livelist of Channel 3
85	Livelist of Channel 4
86	Livelist of this ProfiHub
FF	Livelist of all channels (entire network)

The next 32 input bytes are used for the actual Livelist data. Each address uses two bits. So the first two bits of the first byte are for address 0, the next two bits of the first byte are for address 1 and so on. The bits are used to indicate if the station is a slave device, master device or both.

Device:	Bit 1:	Bit 0:
None	0	0
Slave Device	0	1
Controller	1	0
Both	1	1

Example: If there is a master device on address 2, and a slave device on address 3, then the first byte will be 0x60, because it will look like this:

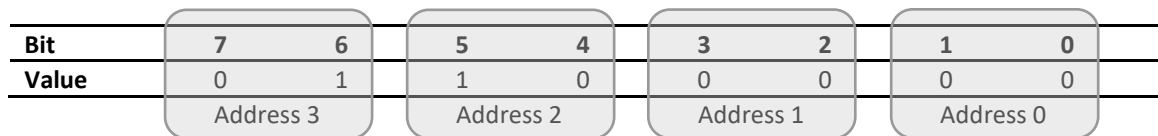

This module also has 2 Output bytes. The first Output byte is used to select the Livelist of a specific Channel. This selection can be read-back in the Input byte described above.

Hex	Meaning
80	Livelist of FO Channel 1
81	Livelist of FO Channel 2
82	Livelist of Channel 1
83	Livelist of Channel 2
84	Livelist of Channel 3
85	Livelist of Channel 4
86	Livelist of this ProfiHub
FF	Livelist of all channels (entire network)

The next Output byte can be used to reset the Livelist. Write 0x01 to this Output byte to reset the Livelist.

### 3.2.10 Statistics (Short Format, Long Format)

Input Identifier byte: 0x30 (short format) or 0x31 (Long Format)

The next byte is used to display the current selection of statistics that it sends.

Hex	Meaning
00..7E	Statistics for device 0..126
7F	Statistics for undefined devices
80	Statistics of FO channel 1
81	Statistics of FO Channel 2
82	Statistics of Channel 1
83	Statistics of Channel 2
84	Statistics of Channel 3
85	Statistics of Channel 4
86	Statistics of this ProfiHub
FF	Statistics of all channels (entire network)

The next 16 bytes (Short Format) or 32 bytes (Long Format) are used to transfer the statistics of the selected address, selected Channel or all Channels of the ProfiHub. Each statistic uses 2 bytes (Short Format, so a maximum of 65535 decimal per statistic) or 4 bytes (Long Format) and is sent in the following order:

1. Lost count
2. Sync count
3. Repeats total count
4. Repeats max per cycle count
5. Illegals count
6. Int. diagnostics count
7. Ext. diagnostics count
8. Diagnostics while in Data Exchange count

This module also has 2 output bytes. The first byte is used to configure the ProfiHub Statistics; you can choose which stations or Channels will display statistics. Configure it by sending the following output value:

Hex	Meaning
<b>00..7E</b>	Statistics for device 0..126
<b>7F</b>	Statistics for undefined devices
<b>80</b>	Statistics of FO Channel 1
<b>81</b>	Statistics of FO Channel 2
<b>82</b>	Statistics of Channel 1
<b>83</b>	Statistics of Channel 2
<b>84</b>	Statistics of Channel 3
<b>85</b>	Statistics of Channel 4
<b>86</b>	Statistics of this ProfiHub
<b>FF</b>	Statistics of all channels (entire network)

The next output byte can be used for clearing the statistics. Please note that the selected statistics of ALL node addresses and/or ProfiHub channels are cleared, not only for the displayed address or channel.

Bit	Meaning
<b>0</b>	Clear LOST statistics
<b>1</b>	Clear SYNC statistics
<b>2</b>	Clear REPEATS TOTAL statistics
<b>3</b>	Clear REPEATS MAX statistics
<b>4</b>	Clear ILLEGALS statistics
<b>5</b>	Clear INT. DIAG statistics
<b>6</b>	Clear EXT. DIAG statistics
<b>7</b>	Clear DIAG WHILE IN DX statistics

Example: To clear all LOST and ILLEGALS statistics, send 0x11  
 To clear all statistics, send 0xFF

### 3.3 Parameterizing the Diagnostic Device

The Diagnostic Device has many user-definable parameters that can be changed, to alter the behaviour and options of the ProfiHub Diagnostics Device.

#### 3.3.1 Diagnostics

The Diagnostics Device sends a diagnostic message on PROFIBUS whenever certain conditions are changed. These changes can be any of the following:

- Livelist change (a station added or removed)
- Bitrate error
- Alarm relay active
- Power status changed (one of the two power sources added or removed)
- Redundancy status change (one of the redundant cables added or removed)
- Termination status change (a termination switch on the ProfiHub has been changed)
- Channel status change (communication stopped or started on a channel)
- Statistics change (any statistic has changed)

In your configuration tool you can toggle the diagnostics for each item.

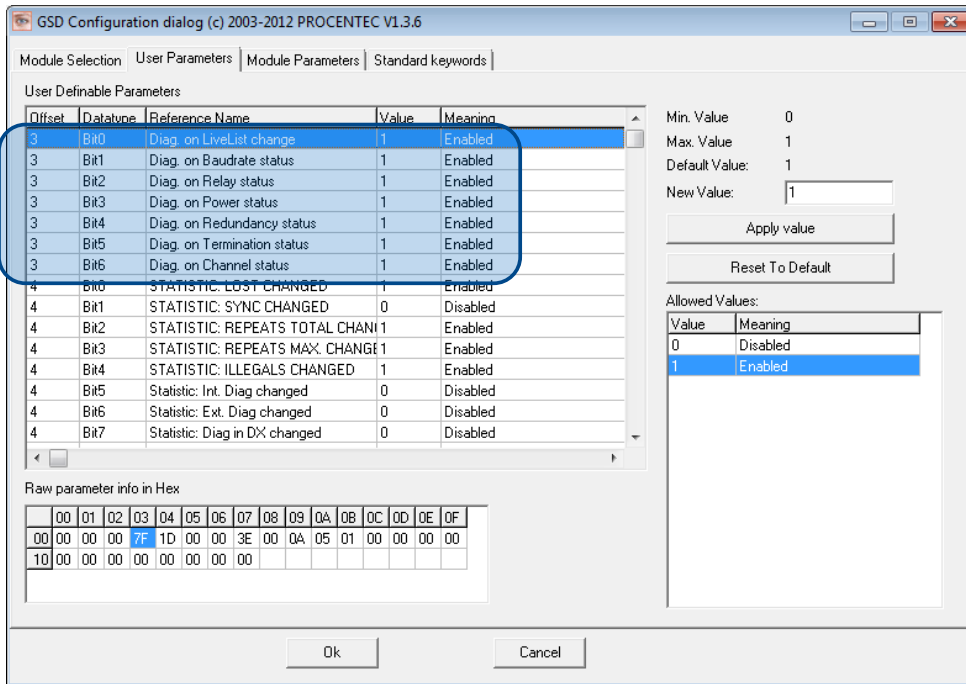

Fig. 22 - Screenshot of ProfiCaptain - User Parameter window

The 8<sup>th</sup> byte of a diagnostic message from the Diagnostic Device indicates which options have been enabled or disabled.

### 3.3.2 Statistics

You can choose which Statistics can trigger a diagnostic message, because not all statistics are interesting in all networks. For example, Syncs have been disabled by default because this is not a statistic that is suitable for PROFIBUS health monitoring.

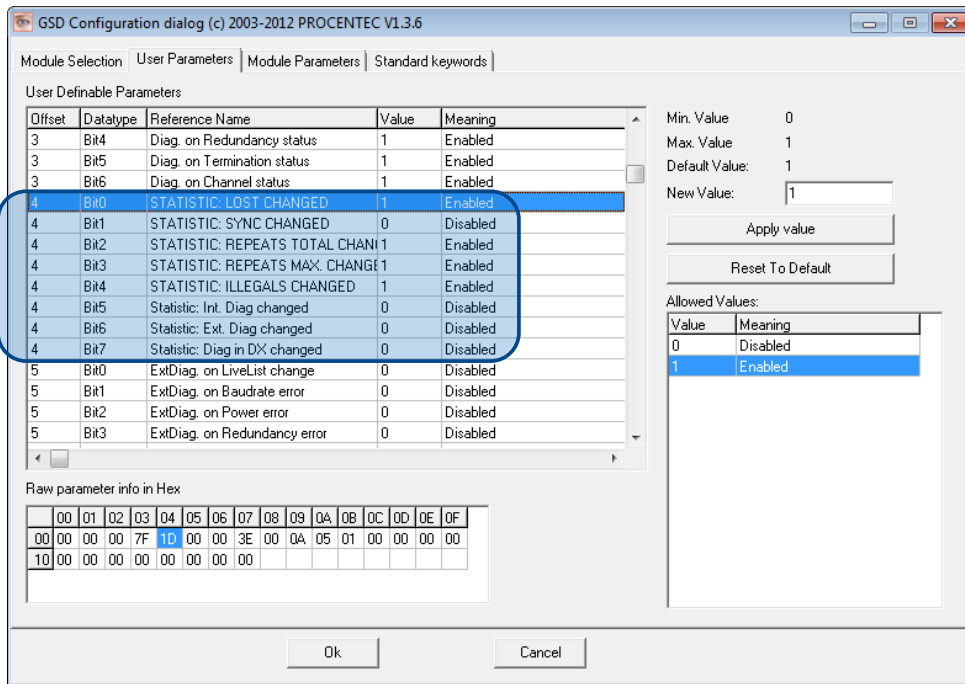

Fig. 23 – You can choose which statistics trigger a diagnostic message

The following Statistics can trigger a diagnostic message of the Diagnostic Device:

- Lost changed
- Sync changed
- Repeats (total) changed
- Repeats (max) changed
- Illegals changed
- Internal Diagnostics changed
- External Diagnostics changed
- Diagnostics in Data Exchange changed

### 3.3.3 Extended Diagnostics on Events change

For more critical applications you can choose to enable the 'Extended Diagnostics' option for each of the previously mentioned events. In the case of such an event, the Diagnostics Device will send out a diagnostics message with the 'Extended Diagnostic' bit on. In a Busmonitor tool such as ProfiTrace the extended diagnostics bit will appear as a red blinking square.

40	41
<b>ProfiHub-B5+ Diagnostics</b>	51
60	61

All Events described in paragraph 3.3.1 can trigger the Extended Diagnostic bit of the Diagnostic Device. By default, the Extended Diagnostic option is disabled. Each item can be enabled individually.



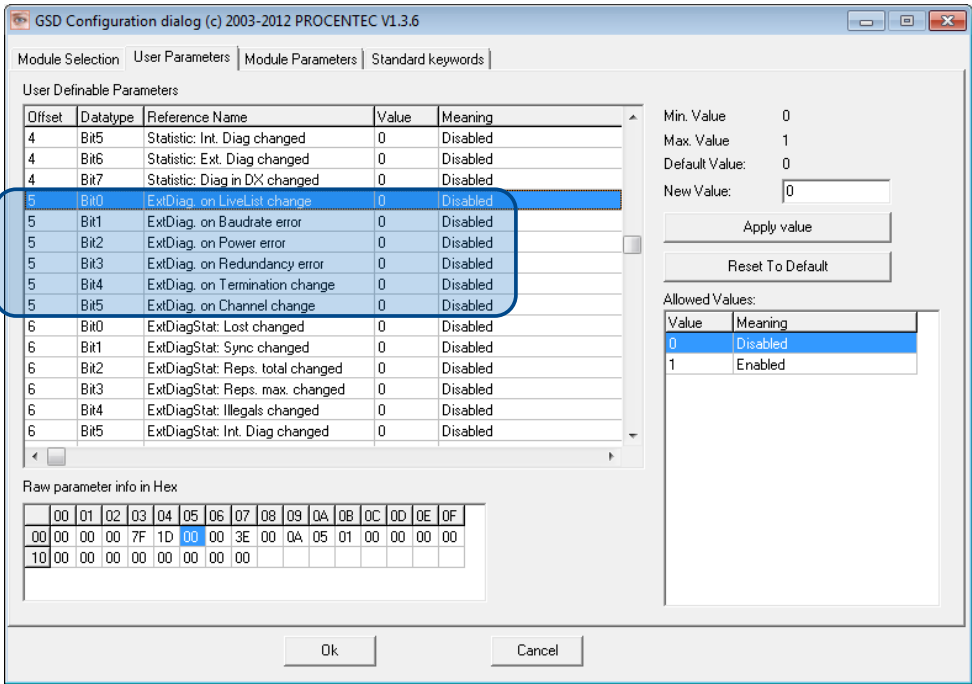

### 3.3.4 Extended Diagnostics on Statistics change

The Extended Diagnostic option can also be enabled for each individual available statistic. This works the same way as the Events described in paragraph 3.3.3.

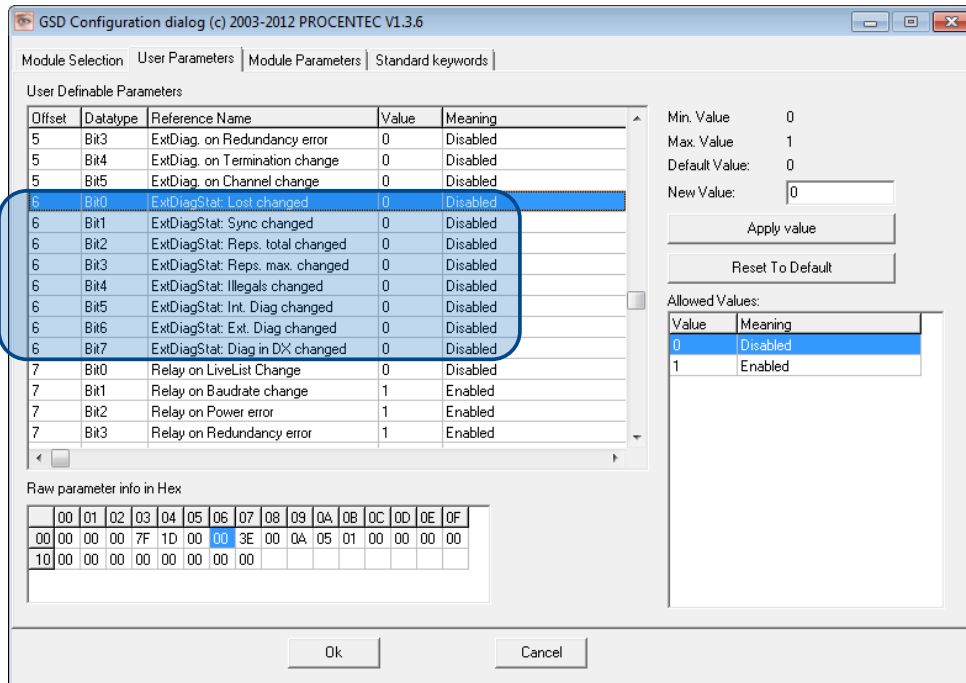

### 3.3.5 Alarm Relay on Events change

The Alarm Relay on the ProfiHub can be switched on each Event described in paragraph 3.3.1. When such an Event occurs, the Relay will be switched immediately without delay. The only Event that can delay the switching of the Alarm Relay is the Lost event.

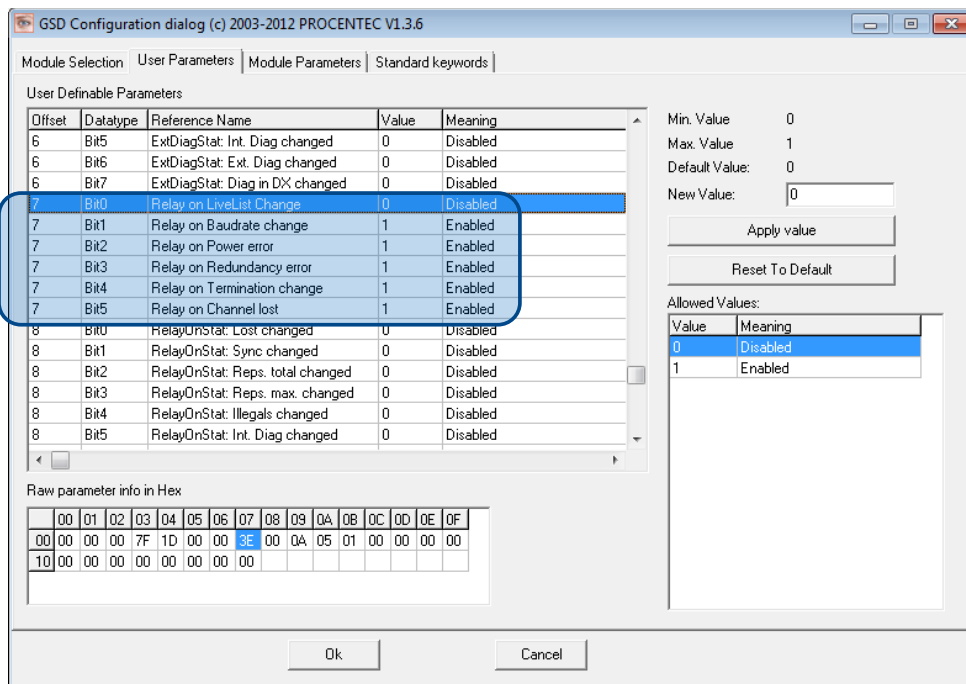

### 3.3.6 Alarm relay on Statistics change

The Alarm Relay on the ProfiHub can be switched (closed) on each change in Statistics, described in paragraph 3.3.2. When such an (enabled) Statistic change occurs, the Relay will be switched immediately without delay. The only Statistic that can delay the closing of the Alarm Relay is the Lost event.

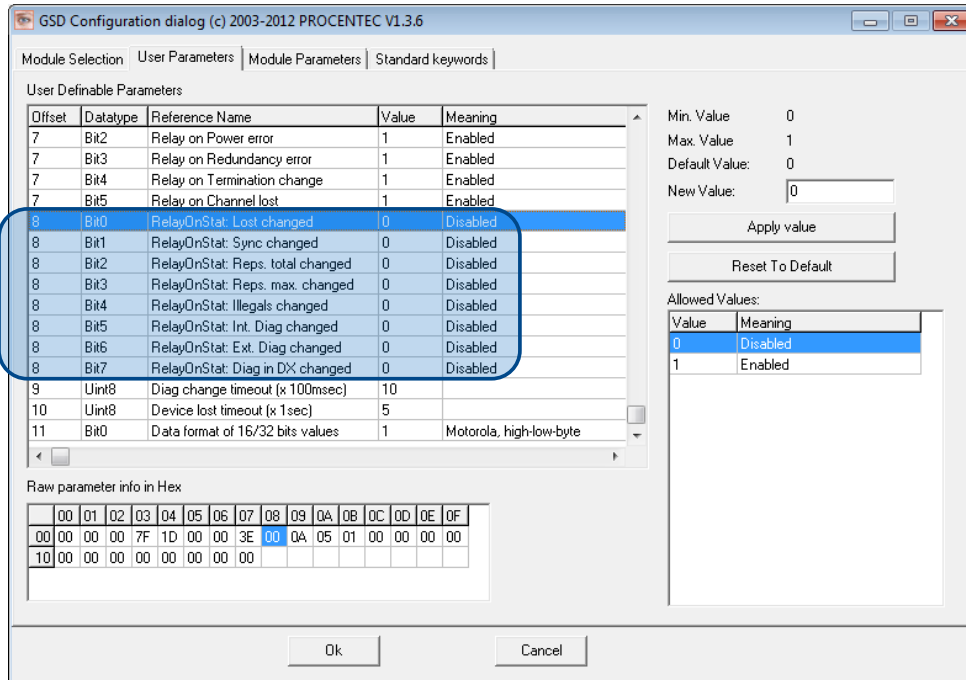

### 3.3.7 Changing the Diagnostics duration/timeout

You can change the duration of the Extended Diagnostics warning in steps of 100 milliseconds. The default value is 10, so 1 second. The maximum value is 255.

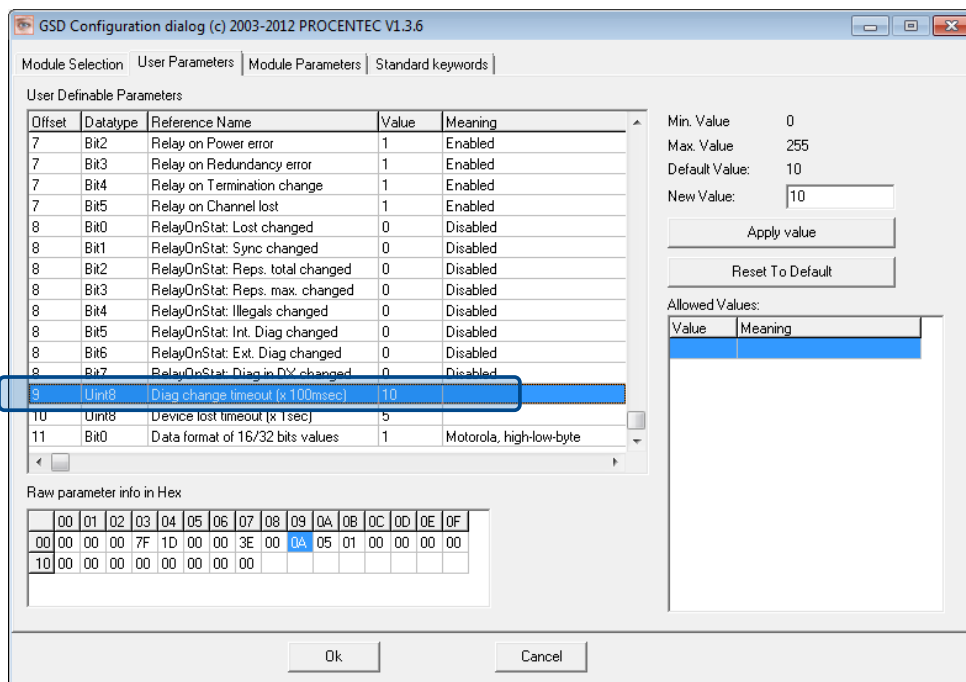

### 3.3.8 Changing the Device Lost timeout

The Diagnostics Device waits for a certain time before it considers a slave to be lost. This works in a similar way as the ProfiTrace Live List, where the background turns yellow when a slave stops communicating. This timeout can be changed in steps of 1 second. Default value is 5, and maximum value is 255.

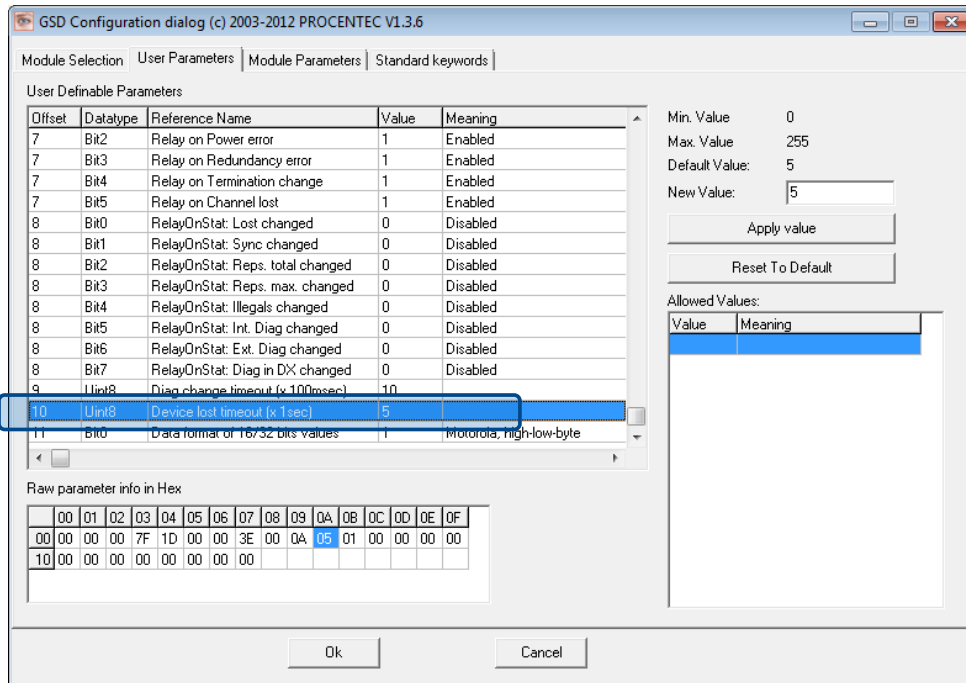

### 3.3.9 Changing the data format

The data format can be changed if needed. Default is Motorola, high-low-byte format. You can change it to Intel, low-high-byte format.

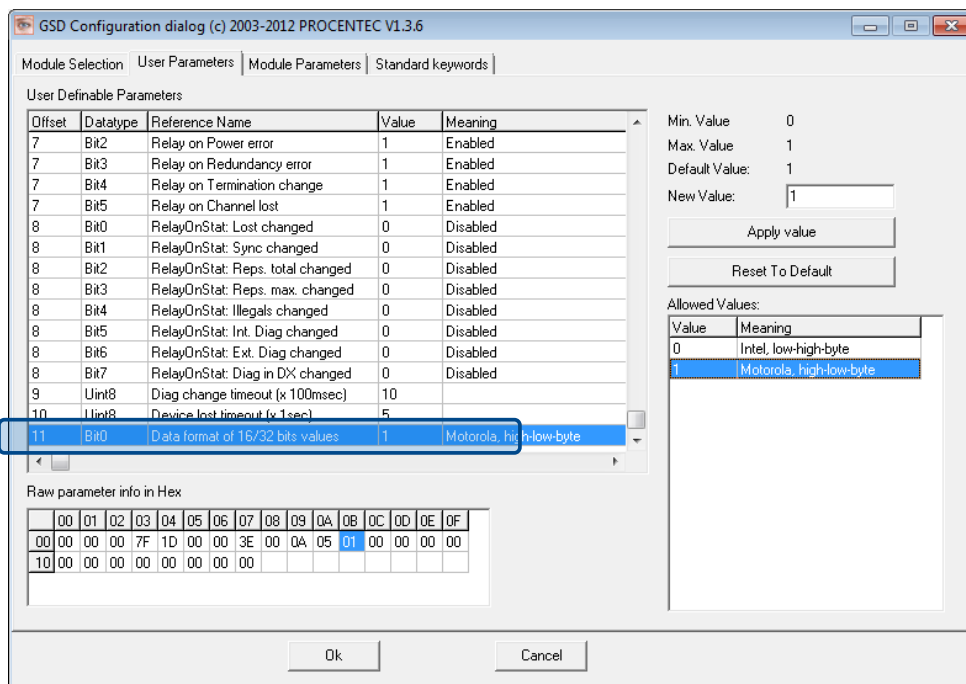

### 3.4 ProfiTrace plugin for the Diagnostic Device

On the download section of [www.procentec.com](http://www.procentec.com) you can download a useful plugin for the Diagnostic Device. It interprets all messages to and from the Diagnostic Device and displays the data in the Info Panel of ProfiTrace.

#### 3.4.1 Installing the Plugin

Once you have downloaded the file and extracted it to your hard drive, start ProfiTrace and choose 'Settings – Plugins' to bring up the Plugin window.

Click 'Install Plugin' and locate it on your harddrive.

Next, click 'Enabled' so that ProfiTrace starts the plugin on startup.

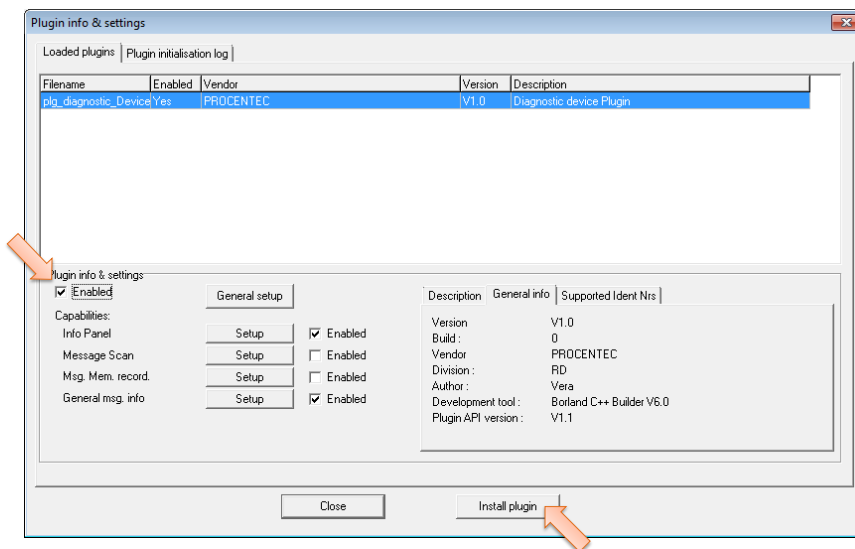

#### 3.4.2 Using the Plugin

When the Plugin is correctly started and you have a ProfiHub with Diagnostics Device running, click 'Start Message Recording' in ProfiTrace, and view the screen with messages (see Fig. 24). If you click on a data exchange message to or from a Diagnostics Device, you will see all the interpreted data bytes in the Info Panel. This is very useful for Troubleshooting activities.

A good example is the Statistics. These statistics are available per individual channel or station address (see paragraph 3.2.10), so it is easy to see the source of the problem.

ProfiTrace for ProfiCore Ultra V2.9.2+ SP1 (c) 2004-2014 PROCENEC ProfiCore Ser.Nr:xxxx00029

File Action Filter Trigger Toolbars View Report Settings Help

ProfiTrace Overview ScopeWare Bar graph Topology Network Manager ProfiCaptain

Load Data Save Data File viewer Setup record trigger Start message recording Stop message recording Set record filter Set view filter

Ini ProfiCore Ultra Close ProfiCore Ultra Auto-detect baudrate Set baudrate Mbps Wizard

System activity: Live list: Message recording: Record to file:

Info Panel

Framestructure: SD2 message  
 Source address: 20  
 Model\_Name: ProfiHub-B2+ Diagnostics  
 Destination address: 1  
 Frametype: Response message

PROFIBUS DP-V0 Message:  
 Data Exchange (Con/Res)

Diagnostic device plugin info:  
 Device type: E2+  
 Version: 0x01  
 Data format: Motorola, high-low-byte

Status cable redundancy: Redundancy not used

Relay status: Relay is on

Power status:  
 Power 1 active  
 Pending alarm: Power 2 not active

Termination:  
 Main channel termination  
 Channel 1 termination

Live list information:  
 Current Selection:  
 Complete device  
 Masters: 1;  
 Slaves: 20/50;

Statistics data:  
 Current Selection: Complete device  
 Lost count: 1  
 Sync count: 25  
 Total repeat count: 2  
 Max repeat count: 1  
 Illegal count: 1  
 Internal diagnose count: 4  
 External diagnose count: 22  
 Diagnose while in data exchange count: 22

FrameNr	Timestamp	Action	Frame	Addr	Service	Msg type	Req/Res	SAPS	DataLen	Data
0	11-Jul-2...		SD2	1<-20	DL	Data Exchange	Res		64	00 01 01 0
1	11-Jul-2...		SD4	1->1	Token pass	Pass token				
2	11-Jul-2...		SD2	1->20	SRD_HIGH	Data Exchange	Req	4	FF 00 FF 0	
3	11-Jul-2...		SD2	1<-20	DL	Data Exchange	Res		64	00 01 01 0
4	11-Jul-2...		SD4	1->1	Token pass	Pass token				
5	11-Jul-2...		SD2	1->20	SRD_HIGH	Data Exchange	Req	4	FF 00 FF 0	
6	11-Jul-2...		SD2	1<-20	DL	Data Exchange	Res		64	00 01 01 0
7	11-Jul-2...		SD1	1->22	FDL Status		Req			
8	11-Jul-2...		SD4	1->1	Token pass	Pass token				
9	11-Jul-2...		SD2	1->20	SRD_HIGH	Data Exchange	Req	4	FF 00 FF 0	
10	11-Jul-2...		SD2	1<-20	DL	Data Exchange	Res		64	00 01 01 0
11	11-Jul-2...		SD4	1->1	Token pass	Pass token				
12	11-Jul-2...		SD2	1->20	SRD_HIGH	Data Exchange	Req	4	FF 00 FF 0	
13	11-Jul-2...		SD2	1<-20	DL	Data Exchange	Res		64	00 01 01 0
14	11-Jul-2...		SD4	1->1	Token pass	Pass token				
15	11-Jul-2...		SD2	1->20	SRD_HIGH	Data Exchange	Req	4	FF 00 FF 0	
16	11-Jul-2...		SD2	1<-20	DL	Data Exchange	Res		64	00 01 01 0
17	11-Jul-2...		SD4	1->1	Token pass	Pass token				
18	11-Jul-2...		SD2	1->20	SRD_HIGH	Data Exchange	Req	4	FF 00 FF 0	
19	11-Jul-2...		SD2	1<-20	DL	Data Exchange	Res		64	00 01 01 0
20	11-Jul-2...		SD4	1->1	Token pass	Pass token				
21	11-Jul-2...		SD2	1->20	SRD_HIGH	Data Exchange	Req	4	FF 00 FF 0	
22	11-Jul-2...		SD2	1<-20	DL	Data Exchange	Res		64	00 01 01 0
23	11-Jul-2...		SD4	1->1	Token pass	Pass token				
24	11-Jul-2...		SD2	1->20	SRD_HIGH	Data Exchange	Req	4	FF 00 FF 0	
25	11-Jul-2...		SD2	1<-20	DL	Data Exchange	Res		64	00 01 01 0
26	11-Jul-2...		SD4	1->1	Token pass	Pass token				
27	11-Jul-2...		SD2	1->20	SRD_HIGH	Data Exchange	Req	4	FF 00 FF 0	
28	11-Jul-2...		SD2	1<-20	DL	Data Exchange	Res		64	00 01 01 0
29	11-Jul-2...		SD4	1->1	Token pass	Pass token				
30	11-Jul-2...		SD2	1->20	SRD_HIGH	Data Exchange	Req	4	FF 00 FF 0	
31	11-Jul-2...		SD2	1<-20	DL	Data Exchange	Res		64	00 01 01 0
32	11-Jul-2...		SD4	1->1	Token pass	Pass token				
33	11-Jul-2...		SD2	1->20	SRD_HIGH	Data Exchange	Req	4	FF 00 FF 0	

00: 00 01 01 01 10 01 12 01 13 21 14 03 20 FF 08 00 00 00 01 00 00 00 00 00 00 00 00 00 00 00  
 20: 00 00 00 00 00 00 00 00 00 00 00 00 00 30 FF 00 01 00 19 00 02 00 01 00 D9 00 04 00 16 00 16

Fig. 24 - Info Panel with ProfiHub Diagnostics information

## 4. Technical Data ProfiHub B4FO2+R

Technical Data ProfiHub B4FO2+R	
<b>Dimensions and weight</b>	
Dimensions L x W x H (mm)	167 x 113 x 43 mm (excluding DIN-rail and plug-able connectors).
Weight	495 g (excluding plug-able connectors, cable brackets and packing material).
Mounting DIN-rail type	35mm x 7.5mm (EN 50022, BS 5584, DIN 46277-3)
<b>Ambient conditions</b>	
Operating temperature	-25 to +70° Celsius -13 to +158° Fahrenheit
Isolation class	IP 20 (IEC/EN 60529, DIN 40050)

**Protocol and timing specifications**

Supported Protocols DP-V0, DP- V1, DP-V2, FDL, MPI, FMS, PROFIsafe, PROFIdrive and any other FDL based protocol.

Transmission speed 9.6 kbps to 12 Mbps (including 45.45 kbps)

Transmission speed detection Auto detect

Transmission speed switch

Rotary switch	Auto detect	Robust repeating	Redundancy	Diagnostic slave
0	•			
1	•	•		
2	•	•	•	
3	•			•
4	•	•		•
5	•	•	•	•
Other	•			

For older ProfiHubs refer to paragraph 2.11.1

Transmission speed detection time < 10 s detection and 50 s baudrate switchover time.

Data delay time Unit

At baudrate	Normal mode	Robust/Redundant mode
9.6 - 500 kbps	3.0 Tbit	14 Tbit
1.5 Mbps	4.0 Tbit	15 Tbit
3 Mbps	4.5 Tbit	15 Tbit
6 Mbps	5.0 Tbit	16 Tbit
12 Mbps	7.0 Tbit	18 Tbit

Jitter per message frame  
 0.0625 Tbit at 9.6 Kbps - 3 Mbps  
 0.125 Tbit at 6 Mbps  
 0.25 Tbit at 12 Mbps

Deviation 2 bit times (over the complete message) for received messages is allowed and is corrected to nominal speed when transmitted.

Fiber optic cable delay calculation

$$T_{SLOT} \geq \text{Max}_{TSDR} + ((FO_{length} \times FO_{delay}) + (N_{FO-modules} \times N_{delay})) \times 2$$

- $FO_{length}$  = Total length of fiber optic cable in km
- $FO_{delay}$  = Delay of fiber optic cable per km in bit
- $N_{FO-modules}$  = Number of fiber optic modules in cascade
- $N_{delay}$  = Delay of one fiber optic module

The delay time is multiplied by 2 for a request and response message

**Example 1: 1.5 Mbps, 3 km FO cable, 2 units Normal mode**

$$FO_{delay} = (FO_{cable\_length} / FO_{cablelatency}) / Bit_{time}$$

$$FO_{delay} = (1000 \text{ m} / 200 \text{ } \mu\text{sec/m}) / 0.666 \text{ } \mu\text{sec} = 7.5 \text{ Tbit/km}$$

$$T_{SLOT} \geq \text{Max}_{TSDR} + ((FO_{length} \times FO_{delay}) + (N_{FO-modules} \times N_{delay})) \times 2$$

$$T_{SLOT} \geq 150 + ((3 \times 7.5) + (2 \times 4)) \times 2 \geq \mathbf{211 \text{ bit times}}$$



PROFIBUS Fiber Optic cable specifications	
Fiber types	<p>Multimode G50/125 <math>\mu\text{m}</math> ISO/IEC 11801 (OM2 or better) IEC 60793-2-10 type A1a TIA/EIA 492AAAB-A ITU-651.1</p> <p>Multimode G62.5/125 <math>\mu\text{m}</math> ISO/IEC 11801 (OM1) IEC 60793-2-10 type A1b TIA/EIA 492AAAA ITU-651.1</p> <p>PCF/HCS 200/230 <math>\mu\text{m}</math></p>
Wavelength	<p>850 nm</p> <p>Compatible with Hirschmann OZD Profi 12M, Siemens OLM G11/G12/G21/G22</p>
Range	<p>G50/125 <math>\mu\text{m}</math> (3 dB/km): 3 km (baud rate independent)</p> <p>G62.5/125 <math>\mu\text{m}</math> (3.5 dB/km): 3 km (baud rate independent)</p> <p>200/230 <math>\mu\text{m}</math> (10dB/km): 200 m (baud rate independent)</p>
Optical Power budget	<p>G50/125 <math>\mu\text{m}</math>: -15.8 dBm</p> <p>G62.5/125 <math>\mu\text{m}</math>: -12 dBm</p> <p>200/230 <math>\mu\text{m}</math>: -4.5 dBm</p>
Connectors	4x ST / BFOC
Redundancy	No

<b>PROFIBUS copper cable specifications</b>																																		
Cable lengths	1200 m at 9.6 kbps to 93.75 kbps 1000 m at 187.5 kbps 400 m at 500 kbps 200 m at 1.5 Mbps 100 m at 3 Mbps to 12 Mbps																																	
Cable thickness	10 mm (when the ground rail is used)																																	
Wire diameter	< 2.5 mm <sup>2</sup>																																	
Wire type	Stranded or Solid core																																	
Number of devices	Maximum 31 per Channel (including ProfiHubs, OLMs etc.)																																	
Termination	Integrated and switchable. Powered according to IEC 61158 (390/220/390 Ohms) - All Channels (default on)																																	
Redundancy	Yes (channel 3 and 4)																																	
Cascading depth	No limits ( <i>only limited by busparameters of the master</i> )  With standard busparameters: <table border="1"> <thead> <tr> <th>At baudrate</th> <th>Normal mode[units]</th> <th>Robust mode[units]</th> </tr> </thead> <tbody> <tr> <td>9.6 kbps</td> <td>6</td> <td>1</td> </tr> <tr> <td>19.2 kbps</td> <td>6</td> <td>1</td> </tr> <tr> <td>45.45 kbps</td> <td>39</td> <td>8</td> </tr> <tr> <td>93.75 kbps</td> <td>6</td> <td>1</td> </tr> <tr> <td>187.5 kbps</td> <td>6</td> <td>1</td> </tr> <tr> <td>500 kbps</td> <td>16</td> <td>3</td> </tr> <tr> <td>1.5 Mbps</td> <td>20</td> <td>5</td> </tr> <tr> <td>3 Mbps</td> <td>17</td> <td>5</td> </tr> <tr> <td>6 Mbps</td> <td>13</td> <td>4</td> </tr> <tr> <td>12 Mbps</td> <td>13</td> <td>5</td> </tr> </tbody> </table> Formula to calculate number of cascading units with adjusted Tslot : Number cascading units = (Tslot - maxTsdr) / (2 × Data_delay_time_unit) * Data_delay_time_unit: Normal or Robust mode see table	At baudrate	Normal mode[units]	Robust mode[units]	9.6 kbps	6	1	19.2 kbps	6	1	45.45 kbps	39	8	93.75 kbps	6	1	187.5 kbps	6	1	500 kbps	16	3	1.5 Mbps	20	5	3 Mbps	17	5	6 Mbps	13	4	12 Mbps	13	5
At baudrate	Normal mode[units]	Robust mode[units]																																
9.6 kbps	6	1																																
19.2 kbps	6	1																																
45.45 kbps	39	8																																
93.75 kbps	6	1																																
187.5 kbps	6	1																																
500 kbps	16	3																																
1.5 Mbps	20	5																																
3 Mbps	17	5																																
6 Mbps	13	4																																
12 Mbps	13	5																																
<b>PROFIBUS Diagnostics Device Specifications</b>																																		
Supported protocol	DP-V0																																	
Ident Number	6973																																	
GSD filename	PROC6973.gsd																																	
Bus address	0-126 (software address only, set by software, default 126)																																	
Transmission speed	9.6 kbps to 12 Mbps (including 45.45 kbps)																																	
Transmission speed detection	Auto Detect																																	
Maximum transferrable data	85 bytes input and 5 bytes output																																	

<b>Power supply specifications</b>	
Power source	Limited Power Source (LPS) or NEC Class 2 or CEC Class 2
Power supply operating voltage	12 to 24 VDC
Power supply absolute max. rated voltage	9 to 31 VDC
Redundant power supply	Yes
Current consumption	300 mA (all Channels fully loaded)
Power dissipation	Max 4.5 W
Reverse polarity protection	Yes
Cable thickness	10 mm (when the ground rail is used)
Wire diameter	< 2.5 mm <sup>2</sup>
<b>Alarm contact</b>	
Voltage	Max. 24 V DC
Current	Max. 0.5 A
<b>Connector lay-out</b>	
2x Power supply POW 1 and POW 2	<u>Plug-able screw connector, pitch 5,08 mm</u> Pin + : 12 to 24 VDC Pin - : 0 V Screw: Shield
Alarm contact	<u>Plug-able screw connector, pitch 5,08 mm</u> Pin 1: relay contact (potential-free) Pin 2: relay contact (potential-free)
PROFIBUS FO Channel 1 to 2	<u>Fiber optic SC connector</u> <u>Q-&gt;: TX</u> <u>Q&lt;-: RX</u>
PROFIBUS Screw terminals Channel 1 to 4	<u>Plug-able screw terminal, pitch 3,81 mm</u> Pin A: PROFIBUS A (green wire) Pin B: PROFIBUS B (red wire) Pin I : Indirect shield
PROFIBUS DB9 Channel 1 to 4	<u>D Sub connector, 9 contacts (PROFIBUS specification)</u> Pin 1: N.C. Pin 2: N.C. Pin 3: PROFIBUS - B Pin 4: PROFIBUS - RTS Pin 5: GND Pin 6: VPP Pin 7: N.C. Pin 8: PROFIBUS - A Pin 9: N.C. Housing: Shield  <i>Shield is connected internally to the DIN-rail Pin I is connected internally with 10nF/1MΩ to shield.</i>

Standards and approvals	
CE	EMC Directive 2014/30/EU, class B Digital Device RoHs Directive 2011/65/EU
FCC	47 CFR 15, Unintentional Radiator, class B Digital Device.
UL	Report reference: E365044-A1-UL  Standards for safety: UL 60950-1, Information Technology Equipment - Safety - Part 1 General Requirements  CAN/CSA C22.2 No. 60950-1-07, Information Technology Equipment - Safety - Part 1: General Requirements

## 5. Sales offices and distributors

### HEADQUARTERS

**PROCENTEC**  
Klopperman 16  
2292 JD WATERINGEN  
Netherlands

T: +31 (0)174 671 800  
F: +31 (0)174 671 801  
E: info@procentec.com  
W: www.procentec.com

### ARGENTINA

**eFALCOM**  
Alcorta 2411  
B1744 - Moreno  
Buenos Aires  
Argentina

T: +54 237 46 31 151  
F: +54 237 46 31 150  
E: santiago.falcomer@efalcom.com  
W: www.efalcom.com

### AUSTRIA

**RELISTE**  
Enzersdorfer Straße 8-10  
A-2345 Brunn am Gebirge  
Austria

T: +43 2236 315 25-25  
F: +43 2236 315 25-60  
E: office@reliste.at  
W: www.relise.at

### AUSTRALIA

**IS Systems Pty Limited**  
14 Laverick Ave.,  
Tomago  
NSW, Australia, 2322

T: +61 2 4964 8548  
F: +61 2 4964 8877  
E: fritz.woller@issystems.com.au  
W: www.issystems.com.au

**Pentair Flow Control Pacific**  
1 Percival Road  
Smithfield  
NSW, Australia, 2164

T: +61 2 4448 0466  
F: +61 2 4423 3232  
E: sharee.hazell@pentair.com.au  
W: www.profibuscentre.com.au

### BELGIUM and LUXEMBOURG

**Bintz Technics N.V.**  
Brixtonlaan 23  
B-1930 Zaventem  
Belgium

T: +32 2 720 49 16  
F: +32 2 720 37 50  
E: bloemen@bintz.be  
W: www.bintz.be

### BRAZIL

**Westcon Instrument. Indl Ltda**  
Rual Alvaro Rodrigues, 257  
São Paulo – SP  
Brazil - CEP 04582-000

T: +55 11 5561-7488  
F: +55 11 5093-2592  
E: paolo@wii.com.br  
W: www.wii.com.br

### CANADA

**Streamline Process Management Inc.**  
#3, 4351 – 104 Ave SE  
Calgary, Alberta T2C 5C6  
Canada

T: +1 403 225 1986  
F: +1 587 585 2828  
E: admin@streamlinepm.com  
W: www.streamlinepm.com

### CHILE

**RP Ingeniería Limitada**  
Tucapel 92 oficina 52  
Concepción  
Chile

T: +56 41 246 93 50  
F: +56 41 252 25 92  
E: rodrigopinto@rpingeneria.cl  
W: www.rpingeneria.cl

### CHINA

**PROCENTEC Beijing**  
Room E-1115 WangJingYuan YouLeHui  
ChaoYang  
Beijing  
China

T: +86 (10)847 669 11 / +86 (10) 847 873 11  
F: +86 (10)847 667 22  
E: info@procentec.net  
W: www.procentec.net

### CZECH REPUBLIC

**FOXON s.r.o.**  
Polní 367  
460 01 Liberec 12  
Czech Republic

T: +420 484 845 555  
F: +420 484 845 556  
E: foxon@foxon.cz  
W: www.foxon.cz

**DENMARK**

**ProSaiCon**  
Jernbanegade 23B  
DK 4000 Roskilde  
Denmark

T: +45 70 20 52 01  
F: +45 70 20 52 02  
E: hfj@prosaicon.dk  
W: www.prosaicon.dk

**EGYPT**

**Mas Trading**  
37, 105 Street  
Al-Etihad Square  
Egypt

T: +2 02 2524 2842  
F: +2 02 2524 2843  
E: aya.elshafei@masautomation.com  
W: www.masautomation.com

**ESTONIA**

**Saksa Automaatika OU**  
Peterburi Tee 49  
Tallinn  
EE-11415 Estonia

T: +372 605 2526  
F: +372 605 2524  
E: info@saksa-automaatika.ee  
W: www.saksa-automaatika.ee

**FINLAND**

**Hantekno Oy**  
Kalliotie 2  
04360 Tuusula  
Finland

T: +358 40 8222 014  
E: info@hantekno.com  
W: www.hantekno.fi

**FRANCE**

**AGILICOM**  
Bâtiment B  
1, rue de la Briaudière  
Z.A. La Châtaigneraie  
37510 BALLAN-MIRE  
France

T: +33 247 76 10 20  
F: +33 247 37 95 54  
E: jy.bois@agilicom.fr  
W: www.agilicom.fr

**GERMANY**

**PROCENTEC GmbH**  
Benzstrasse 15  
D-76185 Karlsruhe  
Germany

T: +49 721 831 663-0  
F: +49 721 831 663-29  
E: info@procentec.de  
W: www.procentec.de

**INDIA**

**UL Engineering Services & Software Pvt Ltd**  
Nirman Classic,  
Katraj-Kondhwa Road,  
Katraj, Pune-411046  
India

T: +91 202 696 0050  
F: +91 202 696 2079  
E: dileep.miskin@ulepl.com  
W: www.ulepl.com

**Automation Combine**  
B.R. House 4<sup>th</sup> Floor,  
Hennur Main Road  
Bangalore 560043  
India

T: +98 452 84 550 / +98 452 030 47  
F: +93 421 375 34 / +93 425 002 90  
E: info@automationcombine.com  
W: www.automationcombine.in

**IRELAND**

**PROFIBUS Ireland**  
Automation Research Centre  
University of Limerick  
National Technology Park, Plassey  
Limerick  
Ireland

T: +353 61 202 107 or +353 61 240 240  
F: +353 61 202 582  
E: info@profibus.ie  
W: www.profibus.ie

**ISRAEL**

**Instrumentics Industrial Control**  
8 Hamlacha St.  
New Industrial Zone  
Netanya, 42170  
Israel

T: +972 9 835 70 90  
F: +972 9 835 06 19  
E: info@instrumentics-ic.co.il  
W: www.inst-ic.co.il

**ITALY**

**PROCENTEC Italy**  
Via Branze n. 43/45  
25123 Brescia  
Italy

T: +39 030 200 8610  
F: +39 030 238 0059  
E: www.procentec.it  
W: www.procentec.it

**JAPAN**

**TJ Group**  
C/O Japanese PROFIBUS Organisation  
West World Building 4F  
3-1-6 Higashi-Gotanda,  
Shinagawa-ku,  
Tokyo, 141-0022  
Japan

T: +81 3 6450 3739  
F: +81 3 6450 3739  
E: info@profibus.jp

**KOREA**

**Hi-PRO Tech. Co., Ltd.**  
#2802, U-Tower, 1029  
Youngduk-dong, Giheung-gu  
Yongin-Si, Kyunggi-do,  
446-908 Korea

T: +82 82 31 216 2640  
F: +82 82 31 216 2644  
E: chays@hiprotech.co.kr  
W: www.profibus.co.kr

**LEBANON**

**Industrial Technologies S.A.L. (ITEC)**  
Point Center, Boulevard Fouad Chehab  
Sin El Fil  
Beirut  
Lebanon

T: +961 1 491161  
F: +961 1 491162  
E: sales@iteclb.com  
W: www.iteclb.com

**MEXICO**

**Grid Connect Inc.**

T: +1 530 219 2565 (Spanish)  
E: tomf@gridconnect.com  
W: www.gridconnect.com

**NETHERLANDS**

**PROCENTEC B.V.**  
Klopperman 16  
2292 JD Wateringen  
Netherlands

T: +31 (0)174 671 800  
F: +31 (0)174 671 801  
E: info@procentec.com  
W: www.procentec.com

**NORWAY**

**Nortelco Automation AS**  
Johan Scharffenbergs vei 95  
N-0694 Oslo  
Norway

T: +47 22 57 61 00  
E: post@nortelcoautomation.no  
I: www.nortelcoautomation.no

**PERU**

**ControlWare**  
Jr. Los Silicios 5409  
Los Olivos - L39  
Peru

T: +51 163 737 35  
F: +51 152 804 54  
E: info@controlware.com.pe  
W: www.controlware.com.pe

**POLAND**

**INTEX Sp. z o.o.**  
ul. Portowa 4  
44-102 Gliwice  
Poland

T: +48 32 230 75 16  
F: +48 32 230 75 17  
E: intex@intex.com.pl  
W: www.intex.com.pl

**PORTUGAL**

**IndustrialSys**  
Rua Alexandre Herculano 25  
Mangualde, 3530-144  
Portugal

T: +351 96 716 16 05  
E: info@industrialsys.pt  
W: www.industrialsys.pt

**ROMANIA**

**S.C. SVT Electronics S.R.L.**  
Brăila 7  
540331 Tg-Mure  
Romania

T: + 40 744 383 666  
F: +40 365 809 305  
E: sajgo.tibor@svt.ro  
W: www.svt.ro

**SAUDI ARABIA**

**ASM Process Automation**  
Al-Zahra Dist. – Attas st.  
cross section with helmy Kutby St.  
Villa no.25  
Jeddah-21553  
Saudi Arabia

T: +966 2 691 27 41  
F: +966 2 682 89 43  
E: info@asmeestablishment.com  
W: www.asmeestablishment.com

**SINGAPORE / SOUTH EAST ASIA**

**Allegro Electronics**  
236 Serangoon Avenue 3 07-98  
Singapore 550236

T: +65 628 780 63  
E: sales@allegro.com.sg  
W: www.allegro.com.sg

**SLOVAKIA**

**ControlSystem s.r.o.**  
Stúrova 4  
977 01 BREZNO  
Slovakia

T: +421 486 115 900  
F: +421 486 111 891  
E: jan.snopko@controlsystem.sk  
W: www.controlsystem.sk

**SOUTH AFRICA**

**IDX ONLINE CC**  
1 Weaver Street  
Fourways  
Johannesburg  
South Africa - 2191

T: +27 (11) 548 9960  
F: +27 (11) 465 8890  
E: sales@idxonline.com  
W: www.idxonline.com

**SPAIN**

**LOGITEK, S.A**  
Ctra. de Sant Cugat, 63 Esc. B Planta 1ª  
Rubí (BARCELONA), 08191  
Spain

T: +34 93 588 67 67  
E: xavier.cardena@logitek.es  
W: www.logitek.es

**SWEDEN**

**P&L Nordic AB**  
Box 252  
S-281 23 Hässleholm  
Sweden

T: +46 451 74 44 00  
E: hans.maunsbach@pol.se  
W: www.pol.se/profibus

**SWITZERLAND**

**Berner Fachhochschule**  
**PROFIBUS Kompetenzzentrum**  
Jlcoweg 1  
CH-3400 Burgdorf  
Switzerland

T: +41 (0) 34 426 68 32  
F: +41 (0) 34 426 68 13  
E: max.felser@bfh.ch  
W: www.profitrace.ch

**TAIWAN**

**Full Data Technology**  
6F., No.200, Gangqian Rd.  
Neihu District, Taipei City  
114, Taiwan

T: +886 2 8751 99 41/90 97  
F: +886 2 8751 95 33  
E: sales@fulldata.com.tw  
W: www.fulldata.com.tw

**TURKEY**

**Emikon Otomasyon**  
DES Sanayi sitesi 103 sokak  
B-7 blok No:16 Yukari Dudullu / Umraniye  
Istanbul 34776  
Turkey

T: +90 216 420 83 47  
F: +90 216 420 83 48  
E: tolgaturunz@emikonotomasyon.com  
W: www.emikonotomasyon.com

**UNITED ARAB EMIRATES**

**Synergy Controls**  
907, IT Plaza Silicon Oasis :  
Dubail  
United Arab Emirates

T: +971 4 326 26 92  
F: +971 4 326 26 93  
E: sales@synergycontrols.ae

**UNITED KINGDOM and N. Ireland**

**Verwer Training & Consultancy**  
5 Barclay Road  
Poynton, Stockport  
Cheshire SK12 1YY  
United Kingdom

T: +44 (0)1625 871 199  
E: andy@verwertraining.com  
I: www.verwertraining.com

**Hi-Port Controls**  
The Hub 2 Martin Close  
Lee-on-Solent  
Hampshire PO13 8LG  
United Kingdom

T: +44 (0)8452 902 030  
F: +44 (0)2392 552 880  
E: sales@hiport.co.uk  
W: www.hiport.co.uk



**iTech**  
Unit 1  
Dukes Road  
Troon  
Ayrshire KA10 6QR  
United Kingdom

T: +44 (0)1292 311 613  
F: +44 (0)1292 311 578  
E: sales@itech-troon.co.uk  
W: www.itech-troon.co.uk

**Parkelect Ltd.**  
84 Dargan Road  
Belfast  
BT3 9JU  
N. Ireland

T: +44 2890 777 743  
F: +44 2890 777 794  
E: jgillan@parkelect.co.uk  
W: www.parkelect.co.uk

#### UNITED STATES

**Grid Connect Inc.**  
1630 W. Diehl Road  
Naperville, Illinois 60563  
USA

T: +1 630 245 14 45  
F: +1 630 245 17 17  
E: sales@gridconnect.com  
W: www.gridconnect.com/procentec.html

#### VIETNAM

**Bavitech Corporation**  
42 Truong Son Street  
Ward 2, Tan Binh District  
Ho Chi Minh City  
Vietnam

T: +84-8-3547 09 76  
F: +84-8-3547 09 77  
E: hai.hoang@bavitech.com  
W: www.bavitech.com

For the complete list of our Sales Offices and Distributors see [www.procentec.com/company/distributors](http://www.procentec.com/company/distributors).

- If your country or region is not listed, please contact us. We are still searching for distributors who can cover complete areas or countries.

## 6. Order codes

Component	Order code	Remarks
 <p><b>ProfiHub B4FO2+R</b></p>	<p>17420R</p>	<p>ProfiHub B4FO2+R With Diagnostics Device            With redundant channels            With Alarm contact            With redundant power input</p> <p>Note: since January 2019, all types have been merged into this single type. All types are drop-in replaceable.</p>

## 7. Certificates

certIFICATE

QualityMasters hereby declares that

**Procentec B.V.**  
Wateringen

has a management system that meets the requirements of the standard

**NEN-EN-ISO 9001:2015**

for the scope

Providing training courses, technical support, product development and the exploitation of the test laboratory.

Date of original approval	10-02-2003
Date of issue	27-01-2017
Valid until	10-02-2019
Certificate number	NL 6594-uk-a

On behalf of Stichting QualityMasters,



N.B. The failure to meet the conditions as set forth in the certification agreement, or non-compliance with the given standard and/or guidelines, may lead to the suspension or cancellation of the certificate.  
This certificate remains the property of Stichting QualityMasters, Nieuwland Parc 157, 3351 LJ Papendrecht.



## Certificate for a PI Competence Center

PI confirms that

**PROCENTEC**  
**Elmer Vis**  
**Klopperman 16**  
**2292 JD Wateringen**  
**NETHERLANDS**

is a fully accredited PI Competence Center for  
PROFIBUS basic  
PROFIBUS Process Automation  
PROFIsafe.

This certificate is granted according to the Quality of Services Agreement for  
PI Competence Centers and is valid for 2 years, until December 31, 2019.



(Official in Charge)



Chairmen of PI



(Karsten Schneider, Chairman)



(Michael Bowne, Deputy Chairman)

## Certificate

PROFIBUS Nutzerorganisation e.V. grants to

### PROCENTEC

Klopperman 16, 2292 JD Wateringen, The Netherlands

the Certificate No: **Z02189** for the PROFIBUS device:

Model Name: ProfiHub-B4F02+RD Diagnostics  
Revision: 1.0; SW/FW: 2.0; HW: 1.3  
GSD: PROC6973.GSD File Version: 2.0

This certificate confirms that the product has successfully passed the certification tests with the following scope:

- DP-V0 MS0, Sync, Freeze, Auto\_Baud, Set\_Slave\_Add
- Physical Layer RS485

Test Report Number: PCN209-DPS-01  
Authorized Test Laboratory: PROCENTEC, Wateringen, The Netherlands

The tests were executed in accordance with the following documents:  
"Test Specifications for PROFIBUS DP Slaves, Version 3.09 from September 2008".

This certificate is granted according to the document:  
"Framework for testing and certification of PROFIBUS and PROFINET products".

For all products that are placed in circulation by **January 02, 2022** the certificate is valid for life.

Karlsruhe, January 29, 2019

Board of PROFIBUS Nutzerorganisation e. V.



(Official in Charge)



(Karsten Schneider)



(Dr. Jörg Hähnliche)



## 8. Glossary

<b>Address</b>	Unique number of a device connected to the network. With PROFIBUS this can be 0 to 126. 127 is a broadcast address.
<b>Analyzer</b>	Software tool to observe the protocol traffic. Combi-Analyzers can also inspect the signal quality. Other term: Bus Monitor. Example: ProfiTrace.
<b>Backbone</b>	The primary bus cable. Most of the time only the control systems, ProfiHubs and fiber optic couplers are connected to this cable. The field devices are connected behind the ProfiHubs and fiber optic couplers.
<b>Bit Time (Tbit)</b>	The bit time Tbit is the time, which elapses during the transmission of one bit. It depends on the baudrate and is calculated as follows $Tbit = 1 \text{ (bit)} / \text{baudrate (bps)}$ . Examples: 12 Mbps --> Tbit = 83 ns 1.5 Mbps --> Tbit = 667 ns
<b>Busparameters</b>	Settings that define the timing behaviour on the bus. They are defined in the master. Examples: Tslot, MaxTSDR.
<b>C</b>	Capacitance.
<b>DGND</b>	Digital Ground.
<b>DIN</b>	German Institute for Standardization ( <a href="http://www.din.de">www.din.de</a> ).
<b>DP-V0</b>	DP-V0 is the basic stage of the PROFIBUS DP communication protocol. DP-V0 devices (master and slaves) perform the following basic functionalities: <ul style="list-style-type: none"><li>- Cyclic exchange of I/O data between controlling and slave devices</li><li>- Device, Identifier (module) and Channel related Diagnosis</li><li>- Parameterization of DP-slaves</li><li>- Configuration of DP-slaves</li></ul>
<b>DP-V1</b>	DP-V1 is the first stage of extension of PROFIBUS DP after DP-V0. DP-V1 devices shall comply with the following features: <ul style="list-style-type: none"><li>- Device related diagnosis is replaced by status and alarms.</li><li>- The first three octets of the user parameterization data are now standardized</li><li>- Optionally these devices may support:</li><li>- Acyclic communication (MS1, MS2)</li><li>- If alarms are used, MS1 shall be supported</li></ul>

<b>DP-V2</b>	<p>DP-V2 is the second stage of extension of PROFIBUS DP after DP-V1. DP-V2 devices shall comply with the following features:</p> <ul style="list-style-type: none"> <li>- Data Exchange Broadcast (DxB) for slave to slave communication (publisher/subscriber principle).</li> <li>- Isochronous Mode (time tick synchronized operating slaves, e.g. drives)</li> <li>- Up- and/or download of Load Region Data (domains)</li> <li>- Clock Control (synchronization within slaves) and Time Stamping</li> <li>- Redundancy.</li> </ul>
<b>Electromagnetic Compatibility</b>	See EMC.
<b>EMC</b>	<p>The extent to which an electric or electronic device will tolerate electrical interference from other equipment (immunity), and will interfere with other equipment. Within the European Community as well as in other countries it is regulated by law that electric and electronic components and equipment comply with basic standards such as IEC 61000-6-2 or IEC 61326 or corresponding individual product standards.</p>
<b>Hub</b>	<p>A Hub refreshes a signal and passes the information on to all nodes which are connected to the Hub. Data frames which were received on one port are transferred to all the other ports (chicken foot topology).</p>
<b>MPI</b>	<p>Multiple Protocol Interface. Protocol defined by Siemens which uses the layer 1 and 2 of PROFIBUS (FDL).</p>
<b>PCB</b>	Printed Circuit Board.
<b>PROFIBUS DP</b>	<p>Acronym for "PROFIBUS for Decentralized Peripherals". Specification of an open fieldbus system with the following characteristics:</p> <ul style="list-style-type: none"> <li>- Polling master-slave-system (cyclic communications, MS0)</li> <li>- Flying masters with robin round token passing coordination (MM)</li> <li>- Connection based (MS1) and connectionless (MS2, MS3) acyclic communication between masters and slaves</li> </ul> <p>Options (e.g.):</p> <ul style="list-style-type: none"> <li>- Data exchange broadcast (DXB), i.e. slave to slaves communication</li> <li>- Isochronous mode of slaves</li> <li>- Clock synchronization</li> <li>- Redundancy</li> </ul> <p>PROFIBUS DP is standardized within IEC 61158 and IEC 61784, communication profile families 3/1 and 3/2</p> <p>The term "PROFIBUS DP" also is a synonym for the RS485 based deployments within factory automation.</p>
<b>Repeater</b>	<p>Active physical layer device that receives and retransmits all signals over a different port to increase the distance and number of devices for which signals can be correctly transferred for a given medium.</p>
<b>Spur line</b>	<p>A cable attached to a bus segment with a T-connection . Spurs are not recommended with PROFIBUS DP. They are prohibited with 12 Mbps and PROFIsafe operations. German term is "Stichleitung".</p>
<b>Stub line</b>	See <i>Spur line</i> .

<b>Tbit</b>	See <i>Bit Time</i> .
<b>Termination</b>	A (powered) resistor network at both ends of a segment to prevent reflections (with PROFIBUS DP the termination must be powered).
<b>Topology</b>	In a communications network, the pattern of interconnection between network nodes; e.g. bus, ring, star configuration.
<b>PI</b>	PROFIBUS International. The International PROFIBUS Organization based in Karlsruhe.
<b>PNO</b>	PROFIBUS Nutzer Organization. The German PROFIBUS Organization based in Karlsruhe.
<b>Drop cable</b>	See <i>Spur line</i> .
<b>Reflection</b>	Part of the original signal that is transmitted back along the cable. It corrupts the original signal.





## 9. About PROCENTEC

**PROCENTEC is a specialist in PROFIBUS and PROFINET technology and develops products to optimize the production processes of end users. Our innovative solutions ensure that our customers successfully operate in the world of industrial automation and enjoy maximum results from their processes.**

PROCENTEC globally supplies all the components required to install a measurable and controllable network. Our products measure, signal and connect the various elements of a process installation and ensure it runs optimally. We develop and produce all products in the Netherlands and export them through our worldwide distribution network. PROCENTEC also is the international accredited Competence and Training center for PROFIBUS and PROFINET. We provide training courses that help employees using those techniques optimally for their business objectives. In addition we also provide the necessary support to end users during their implementation procedures, certification processes, audits and malfunctions.

We are of the opinion that the industrial markets need the confidence of believing in the reliable PROFIBUS / PROFINET technology and applications, to ensure their processes are not threatened in any way and the continuity remains guaranteed. In view of the possible negative consequences and impact in that industry, we therefore think that those companies have the right to the best solutions and honest expert advice. Based on that belief, PROCENTEC continues to innovate and develop, which makes us the most reliable service provider and knowledge partner for our customers. We do all of this with total dedication.

We believe that it is important to communicate with our customers, partners, distributors and suppliers in a transparent and decent way. We are empathic, truly interested and passionate in everything we do. Quality, continuity, service and sustainability are essential to us. That enables us to provide our customers with groundbreaking and tailor-made solutions.

### Products

- ProfiTrace
- ComBricks
- ProfiHub
- PROFINET tools
- Cables and connectors

### Training courses

- PROFIBUS training courses
- PROFINET training courses
- Product training courses

### Services

- Competence center
- Support & Consultancy
- Network certification & Audits
- Testlab & Democenter



## 10.Revision history

### **Version 1.0**

- Initial release

### **Version 1.0.2**

- Updated chapter 'Technical Data'

### **Version 2.0.0**

- Changed manual to adapt to Diagnostics feature for ProfiHub family and ComBricks.







PROCENTEC BV  
Klopperman 16  
2292 JD Wateringen  
The Netherlands

T: +31 (0)174 671 800

F: +31 (0)174 671 801

E: [support@procentec.com](mailto:support@procentec.com)

W: [www.procentec.com](http://www.procentec.com)

